

TOLERANCE UNLESS OTHERWISE SPECIFIED IN MM:	ANGLE
0	3°
±0.50	
±0.38	
0.00	
±0.25	
0.000	
±0.10	

THIS IS A C.A.D. GENERATED DRAWING
DO NOT MAKE MANUAL REVISIONS TO MASTER.

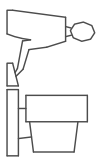

ISSUE NUMBER
ORIGINAL
①

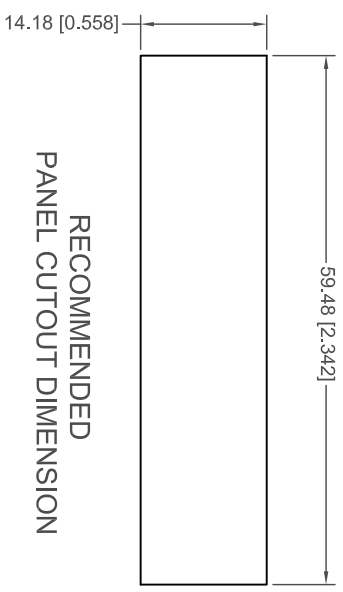
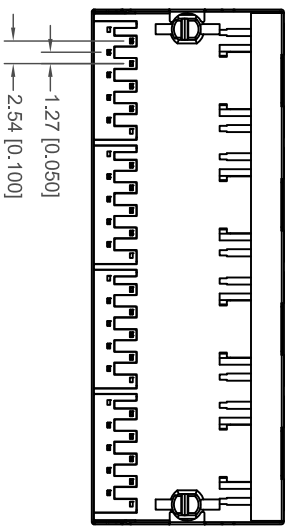
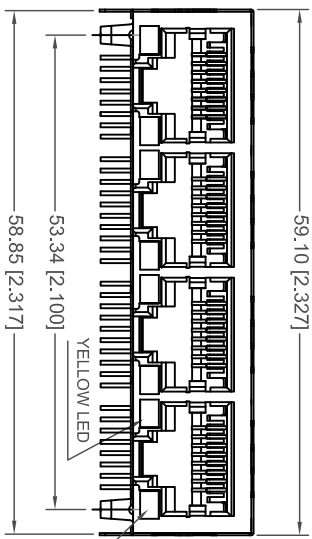
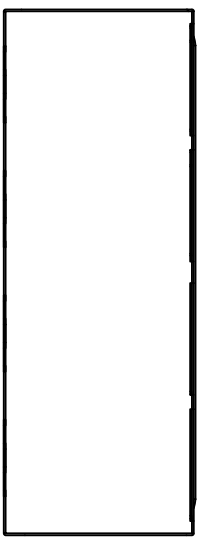

**RECOMMENDED
PANEL CUTOUT DIMENSION**

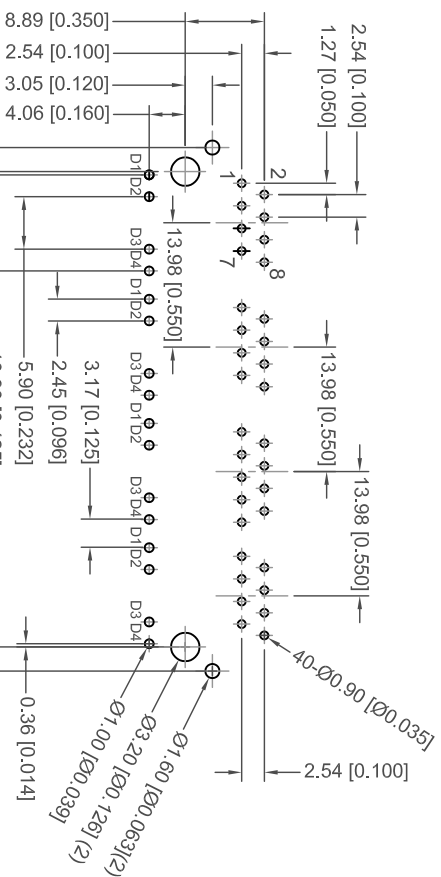
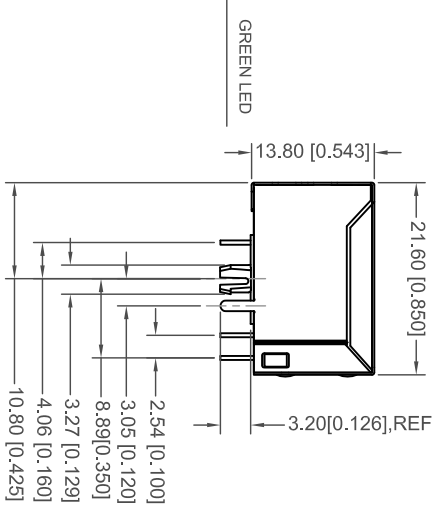

**RECOMMENDED P.C.B. LAYOUT
TOLERANCE: ±0.05[±0.002]**

- NOTES:**
1. MATERIALS:
HOUSING: PBT WITH GLASS FIBER, UL94 V-0, COLOR: BLACK
CONTACTS: 0.30MM PHOSPHOR BRONZE PLATED WITH GOLD PLATING AND TIN IN SOLDER AREA
OVER 50u" NICKEL PLATING ALL OVER

PART NO	GOLD PLATING THICKNESS
A63-142-313P161	GOLD FLASH PLATING
A63-143-313P161	15 MICRO INCHES OF GOLD
A63-144-313P161	30 MICRO INCHES OF GOLD

2. SHIELD: 0.25MM COPPER ALLOY WITH NICKEL PLATING
3. OPERATING TEMPERATURE: 0°C TO +70°C
4. MATE WITH MODULAR PLUG CONFORMING TO FCC PART 68, SUBPART F.
5. DIMENSION: MM [INCHES]

**4 PORT, RJ45 MAGNETIC JACK WITH LED, 8P, 8C
SHIELDED/10/100 Mbps FILTER**

ACAD REFERENCE NO.: A63-143-313P161

DRAWN: R.STA.MONICA DATE: NOV.19/2010

CHECKED: DATE:

PART NUMBER SHEET 1 OF 2

SEE NOTE

DRAWING NUMBER ISSUE

A63-142-313P161 1



THIS SERIES FULLY CONFORMS TO THE
EUROPEAN UNION DIRECTIVES 2002/95/EC
AND 2002/96/EC FOR ROHS COMPLIANCY.

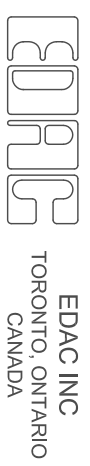

TORONTO, ONTARIO
CANADA
YOUR CONNECTION TO QUALITY & SERVICE

ELECTRICAL CIRCUIT:

TOLERANCE UNLESS OTHERWISE SPECIFIED IN MM:	ANGLE	3°
0		
±0.50		
±0.38		
0.00		
±0.25		
±0.10		

THIS IS A C.A.D. GENERATED DRAWING
DO NOT MAKE MANUAL REVISIONS TO MASTER.

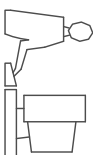

ISSUE NUMBER
ORIGINAL

①

CONNECTOR SOLDER SIDE

RJ45 CONTACT SIDE

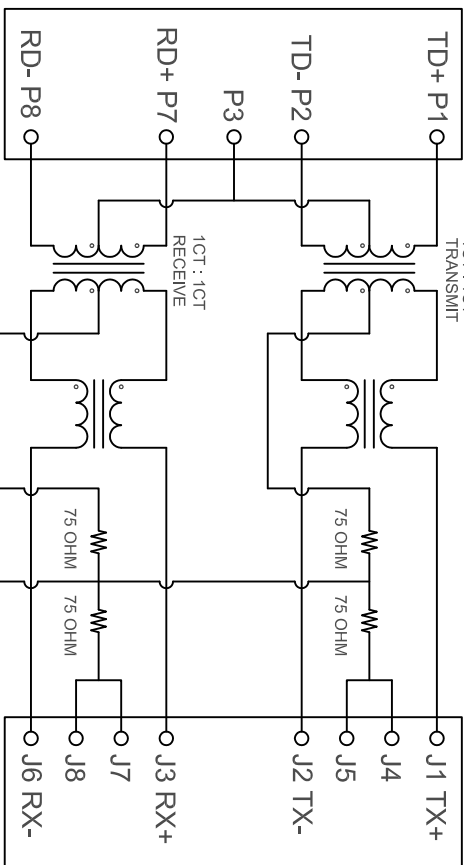

LED CIRCUIT:

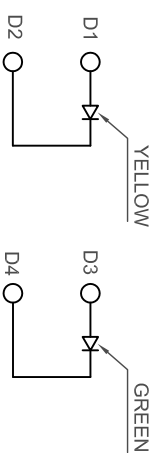

Color	Lens Color	V _f (V) @20mA	I _v (mcd) @10mA	Min	Max	Typ	Viewing angle
							2θ 1/2
Yellow	Yellow Diffused	1.7	3.0	1.7	2.8	6.0	116
Green	Green Diffused	1.7	3.5	1.7	2.8	6.0	116

**4 PORT, RJ45 MAGNETIC JACK WITH LED, 8P, 8C
SHIELDED/10/100 Mbps FILTER**

- TEST NOTES:(25±5°C)
- 1.TR:(100KHz,0.1V):
PINS:(P1-P2):(J1-J2)=1:1±3%
PINS:(P7-P8):(J3-J6)=1:1±3%
 - 2.LX:(100KHz,100mV,8mA, DC Bias)
PINS: (P1,P2),(P7,P8)=350ΩH MINIMUM
 - 3.DCR:
PINS:(J1-J2),(J3-J6)= 1.2 OHMS MAXIMUM
 - 4.HPOT:
PINS(P1,P3,P2)TO(J1,J2)=1500VAC FOR 2 SECONDS
PINS(P7,P3,P8)TO(J3,J6)=1500VAC FOR 2 SECONDS
 - 5.INSERTION LOSS:
-1.0dB MAXIMUM AT 1MHZ TO 100MHZ;
 - 6.RETURN LOSS:
-20DB MINIMUM AT 1MHZ TO 30MHZ;
-15DB MINIMUM AT 30MHZ TO 60MHZ
-10DB MINIMUM AT 60MHZ TO 80MHZ
 - 7.CROSS TALK:
-30DB MINIMUM AT 1MHZ TO 100MHZ
 - 8.COMMON TO COMMON MODE REJECTION:
-30DB MINIMUM AT 1MHZ TO 100MHZ



THIS SERIES FULLY CONFORMS TO THE
EUROPEAN UNION DIRECTIVES 2002/95/EC
AND 2002/96/EC FOR ROHS COMPLIANCY.

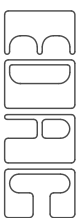

EDAC INC
TORONTO, ONTARIO
CANADA

YOUR CONNECTION TO QUALITY & SERVICE

THESE DRAWINGS AND SPECIFICATIONS
ARE THE PROPERTY OF EDAC INC. AND
SHALL NOT BE REPRODUCED OR COPIED
OR USED AS THE BASIS FOR THE
MANUFACTURE OR SALE OF APPARATUS
WITHOUT WRITTEN PERMISSION.

ACAD REFERENCE NO.: A63-143-313P161

DRAWN: R.STA.MONICA DATE: NOV.19/2010

CHECKED: DATE:

PART NUMBER

SEE NOTE

SHEET 2 OF 2

DRAWING NUMBER

A63-142-313P161

ISSUE

1