



# USER MANUAL

Version 1.0.0

**Promi-SD™  
205-OA**

**Bluetooth RS232C Serial Adapter**

**by Bluetooth**  
**Enabling Wireless Serial Communications**

For more information and Technical Support, please contact:

Sena Technologies, Inc.  
210 Yangjae-dong, Seocho-gu  
Seoul 137-130, Korea  
Tel : (+82-2)-573-5422  
Fax : (+82-2) 573-7710  
E-Mail : [support@sena.com](mailto:support@sena.com)  
Website : <http://www.sena.com>

**Worldwide Sales:**

AVE Added Value Electronics BV  
Vissersdijk Beneden 17  
3319 GW Dordrecht  
The Netherlands  
Mr. Johan B. Bickel  
Sales Manager  
Tel. +31 (0)78 – 6215900  
Fax +31 (0)78 -6215815  
[johan@ave-nl.com](mailto:johan@ave-nl.com)  
<http://www.ave-nl.com>

# Table of Contents

<b>Before Using the Product .....</b>	<b>3</b>
Welcome.....	3
Copyrights/Certification/Limited Liability .....	3
Precautions and Safety.....	3
General Terms and Conditions of Sale.....	3
<b>1. Getting Started .....</b>	<b>7</b>
Features of Promi-SD.....	7
Components.....	7
Assembly.....	7
Locating the Controls .....	7
<b>2. Configurations .....</b>	<b>12</b>
Operation Modes.....	12
LED Indicators .....	12
Serial Ports.....	12
Reset to Factory Defaults .....	12
PromiWizardP™P .....	12
PromiWINP™P .....	12
Terminal Program .....	12
Dip Switch.....	12
Pairing Button.....	12
<b>3. Connections .....</b>	<b>22</b>
RS232 Interface.....	22
Pin Assignment.....	22
Power Supply .....	22
<b>4. Trouble Shooting .....</b>	<b>25</b>
No Data Transmission.....	25
Data Loss or Malfunctioning.....	25
Transmission Delay .....	25
<b>5. Specifications .....</b>	<b>27</b>
Bluetooth Interface.....	27
Serial Interface.....	27
Power .....	27
Mechanical Dimensions.....	27
Environmental.....	27
Default Antenna.....	27
Power Consumption.....	27
Wireless Coverage .....	27

---

<b>Appendix A. AT Commands .....</b>	<b>1</b>
Terminology.....	1
Command Category .....	1
Command Description.....	1
Command Validity .....	1
<b>Appendix B. S-Register .....</b>	<b>1</b>
<b>Appendix C. Technical Support.....</b>	<b>1</b>
<b>Appendix D. Connection to Omron PLC .....</b>	<b>1</b>

# Before Using the Product

**Welcome**

**Copyrights/Certification/Limited Liability**

**Precautions and Safety**

**General Terms and Conditions of Sale**

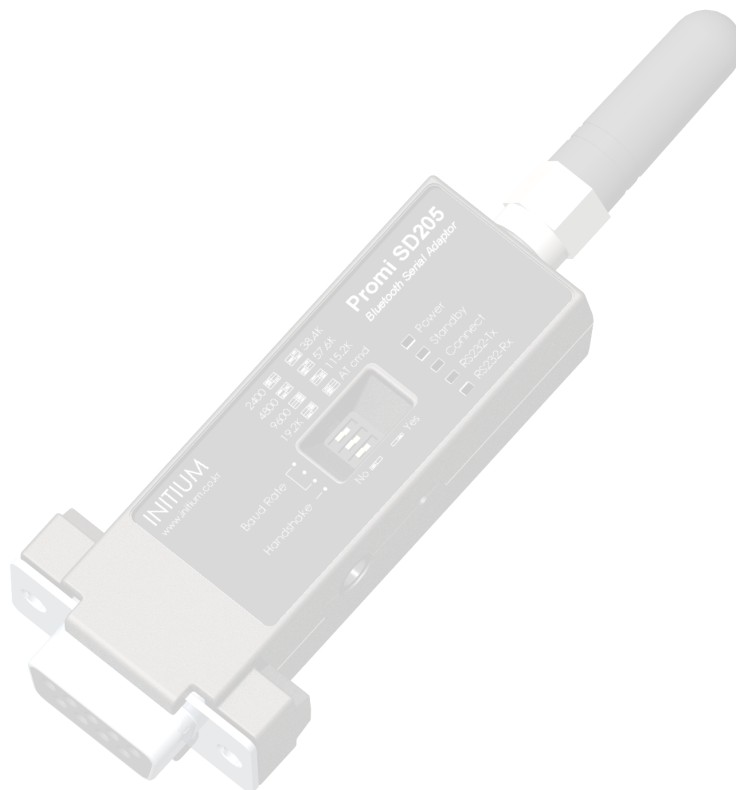

get **UNWIRED**, it's easy!

## Welcome

Thank you for purchasing Promi-SD products.

Promi-SD is a terminal device for wireless serial communication using Bluetooth technology, the international standard for short range wireless communications. Its interoperability and credibility delivers the maximum benefits of wireless communication.

This user manual is designed to help you use the Promi-SD series properly. It is important that you read the manual to ensure that you get the most out of your products.

Thank you.

## Copyrights/Certification/Limited Liability

### ✎ Copyrights

Sena Technologies, Inc. has all the rights of the patent, trademark, literary property and intellectual property related to this manual. You may not copy or reproduce any part of this manual unless authorized by Sena Technologies, Inc. You can be punished by using any part of this manual illegally.

The companies, institutions, products, people and events used in examples are not real data. We don't have any intention to be related with any companies, institutions, products, people and events through this manual and should not draw inferences. Users are responsible for observing the copyrights and intellectual properties.

### ✎ Certification

Promi-	MIC	Bluetooth	CE	FCC	TELEC
SD205_OA			O	O	

### ✎ Limited Liability

Neither the manufacturer, importers nor dealers is responsible for any accidental damage including bodily injury or any damage resulting from misuse or unsuitable operation by you. The information on this manual is prepared with the current product specifications. The manufacturer, Sena Technologies, Inc., is adding new features to the product and may persistently apply new technologies hereafter. All standards may be changed at any time without notice.

## Precautions and Safety

### ✎ Electricity

- Use only the supplied AC adapter. Use of unauthorized power adapter is not recommended. Electrical shock may result.
- Do not kink or crease the power cable or place heavy objects on the power cable. Fire can result from damaged power cables.
- Do not handle power plug and adapter with wet hands. Electrical shock may result.
- Immediately power off the product and unplug the AC adapter if smoke or odors emit from the product and adapter. Fire can result from improper use.
- Immediately power off the product and unplug the AC adapter if water or other liquids are present. Fire can result from improper use.

### ✎ Product

- Promi-SD meets the RS-232 standards. Do not wire with non-standard products. Damage to your products may result from improper use.
- Do not drop or subject the device to impact. Damage to your products may result from improper use.

- Keep away from harsh environments including humid, dusty, and smoky areas. Damage to your products may result from improper use.
- Do not use excessive force on the buttons or attempt to disassemble the device. Damage to your products may result from improper use.
- Do not place heavy objects on the product. Damage to your products may result from improper use.

## General Terms and Conditions of Sale

**1. GENERAL.** These general terms and conditions of sale (along with any associated written specification, quotation and/or supplemental terms and conditions provided by Seller) exclusively will govern the sale or licensing by Seller of all goods and services (including without limitation, hardware, firmware and software products, training, programming, maintenance, engineering, parts, repair and remanufacturing services – hereinafter, "Products") furnished to Buyer hereunder, whether such sale or licensing is effected by paper-based transactions or via facsimile or other forms of electronic data interchange or electronic commerce, and represents the entire agreement between Buyer and Seller with respect thereto. Buyer's receipt or acceptance of delivery of any of the Products ordered or purchased hereunder will constitute its acceptance of these terms and conditions. No addition or modification to these terms and conditions will be binding on Seller unless agreed to in writing signed by an authorized representative at Seller's headquarters. Seller objects to and rejects other terms and conditions that may be proposed by Buyer or that appear on or are referenced in Buyer's purchase order or requisition that are in addition to or otherwise not consistent with the terms and conditions set forth or referenced herein. This product is produced by SENA Technologies, Inc.

**2. WARRANTY.** (a) Hardware: Seller warrants that new hardware Products furnished here-under will be free from defects in material, workmanship and design for a period of one (1) year from the date of invoice from Seller or its appointed distributor, as the case may be. Repaired or replacement Products provided as a result of this warranty subparagraph are similarly warranted for a period of six (6) months from the date of shipment to Buyer or the remainder of the original warranty term for that particular Product, whichever is longer. (b) Software and Firmware: Unless otherwise provided in a Seller or third party license, Seller warrants that standard software or firmware Products furnished hereunder, when used with Seller-specified hardware, will perform in accordance with published specifications prepared, approved, and issued by Seller for a period of one (1) year from the date of invoice from Seller or its appointed distributor, as the case may be. Seller makes no representation or warranty, express or implied, that the operation of the software or firmware Products will be uninterrupted or error free, or that the functions contained therein will meet or satisfy Buyer's intended use or requirements. (c) Non-Warranty Factory Remanufacture, Repair and Field Exchange: Seller warrants that non-warranty factory remanufactured or field exchanged hardware Products or repaired hardware Product components will be free from defects in material and workmanship for a period of one (1) year from the date of invoice from Seller or its appointed distributor, as the case may be. Repaired or replacement Products provided as a result of this warranty subparagraph are warranted for a period of thirty (30) days from the date of shipment to Buyer or the remainder of the original warranty term, whichever is longer. (d) Services: Seller warrants that Products comprised solely of services (e.g., training, on-site repair, engineering and custom application programming services) will be performed by appropriately skilled personnel employed or retained by Seller. (e) "Open Box" Products: Seller warrants that hardware Products sold as "Open Box" (e.g., customer and distributor returns, factory refurbished or reconditioned, etc.) will be free from defects in material and workmanship for a period of ninety (90) days from the date of invoice from Seller or its appointed distributor, as the case may be. "Open Box" Products, while serviceable, may not reflect the latest series or revision. Repaired or replacement Products provided as a result of this warranty subparagraph are similarly warranted for a period of thirty (30) days from the date of shipment to Buyer or the remainder of the original ninety-day warranty term for that particular Product, whichever is longer. (f) Buyer Specifications/Compatibility: Seller does not warrant and will not be liable for any design, materials, construction criteria or goods furnished or specified by Buyer (including that sourced from other manufacturers or vendors specified by Buyer). Any warranty applicable to such Buyer-specified items will be limited solely to the warranty, if any, extended by the original manufacturer or vendor directly or indirectly to Buyer. Seller does not warrant the compatibility of its Products with the goods of other manufacturers or Buyer's application except to the extent expressly represented in Seller's published specifications or written quotation. (g) Recyclable Materials: In keeping with environmental policies and practices, Seller reserves the right to utilize in its product manufacturing, repair and remanufacturing processes certain recyclable materials (e.g., fasteners, plastics and the like) or remanufactured parts equivalent to new in performance or parts which may have been subject to incidental use. However, such utilization will not affect any provided Product warranty or published reliability statistics. (h) Remedies: Remedies under the above warranties will be limited, at Seller's option, to the replacement, repair, re-performance or modification of, or issuance of a credit for the purchase price, of the Products involved, and where applicable, only after the return of such Products pursuant to Seller's instructions. Replacement Products may be new, remanufactured, refurbished or reconditioned at Seller's discretion. Buyer requested on-site warranty service (consisting of time, travel and expenses related to such services) will be at Buyer's expense. The foregoing will be the exclusive remedies for any breach of warranty or breach of contract arising therefrom. (i) General: Warranty satisfaction is available only if (a) Seller is provided prompt written notice of the warranty claim and (b) Seller's examination discloses that any alleged defect has not been caused by misuse; neglect; improper installation, operation, maintenance, repair, alteration or modification by other than Seller; accident; or unusual deterioration or degradation of the Products or parts thereof due to physical environment or electrical or electro-magnetic noise environment. (j) THE ABOVE WARRANTIES ARE IN LIEU OF ALL OTHER WARRANTIES AND CONDITIONS, WHETHER EXPRESSED, IMPLIED OR STATUTORY, INCLUDING IMPLIED WARRANTIES OF MERCHANTABILITY OR FITNESS FOR A PARTICULAR USE, OR PERFORMANCE OR APPLICATION WARRANTIES, TO THE FULLEST EXTENT PERMITTED BY APPLICABLE LAW. Rights under the above warranties (subject to noted limitations) extend to Buyer's customers if Buyer is a Seller-appointed distributor for the Products.

**3. DISCLAIMER AND LIMITATION OF LIABILITY.** TO THE FULLEST EXTENT PERMITTED BY APPLICABLE LAW, SELLER WILL NOT BE LIABLE FOR ANY BUSINESS INTERRUPTION OR LOSS OF PROFIT, REVENUE, MATERIALS, ANTICIPATED SAVINGS, DATA, CONTRACT, GOODWILL OR THE LIKE (WHETHER DIRECT OR INDIRECT IN NATURE) OR FOR ANY OTHER FORM OF INCIDENTAL, INDIRECT OR CONSEQUENTIAL DAMAGES OF ANY KIND. SELLER'S MAXIMUM CUMULATIVE LIABILITY RELATIVE TO ALL OTHER CLAIMS AND LIABILITIES, INCLUDING OBLIGATIONS UNDER ANY INDEMNITY, WHETHER OR NOT INSURED, WILL NOT EXCEED THE COST OF THE PRODUCT(S) GIVING RISE TO THE CLAIM OR LIABILITY. SELLER DISCLAIMS ALL LIABILITY RELATIVE TO GRATUITOUS INFORMATION OR ASSISTANCE PROVIDED BY, BUT NOT REQUIRED OF SELLER HEREUNDER. ANY ACTION AGAINST SELLER MUST BE BROUGHT WITHIN EIGHTEEN (18) MONTHS AFTER THE CAUSE OF ACTION ACCRUES. THESE DISCLAIMERS AND LIMITATIONS OF LIABILITY WILL APPLY REGARDLESS OF ANY OTHER CONTRARY PROVISION HEREOF AND REGARDLESS OF THE FORM OF ACTION, WHETHER IN CONTRACT, TORT (INCLUDING NEGLIGENCE AND STRICT LIABILITY) OR OTHERWISE, AND FURTHER WILL EXTEND TO THE BENEFIT OF SELLER'S VENDORS, APPOINTED DISTRIBUTORS AND OTHER AUTHORIZED RESELLERS AS THIRD-PARTY BENEFICIARIES. EACH PROVISION HEREOF WHICH PROVIDES FOR A LIMITATION OF LIABILITY, DISCLAIMER OF WARRANTY OR CONDITION OR EXCLUSION OF DAMAGES IS SEVERABLE AND INDEPENDENT OF ANY OTHER PROVISION AND IS TO BE ENFORCED AS SUCH.

**4. INTELLECTUAL PROPERTY INDEMNITY.** Except as excluded herein, Seller will defend any suit or proceeding brought against Buyer arising out of a claim that the design or construction of the Products sold or licensed hereunder by Seller infringes any patent, copyright or trademark granted or registered in the country of Seller's shipping destination, provided (a) Buyer promptly notifies Seller in writing of any such claim and any suit or proceeding, (b) at Seller's expense, Buyer gives Seller the sole right to defend, settle and control the defense of the suit or proceeding, (c) Buyer provides all necessary information and assistance for such defense or settlement, and (d) Buyer takes no position adverse to Seller in connection with such claim. In the event Seller is obligated to defend such suit or proceeding, Seller will pay all costs and damages finally awarded or agreed upon by Seller that are directly related thereto. Seller's obligations under this paragraph will be fulfilled if Seller, at its option and expense: (i) procures for Buyer the right to continue using such Products, (ii) replaces the same with non-infringing equipment/software having functionality similar to that of the Products, (iii) modifies the Products to make them non-infringing while retaining similar functionality, or (iv) if (i)-(iii) are not commercially practicable, refunds to Buyer the purchase price of the affected Products in exchange for their return. Seller will have no obligation to defend or for any other liability with respect to: [a] any suit or proceeding to the extent based on or arising out of a configuration or modification made, specified or requested by Buyer and which is incorporated into or constitutes the Products, [b] the use of the Products in a process or application specified, requested or controlled by Buyer or any third parties, or [c] the use of the Products in combination with other equipment, software or materials not supplied by Seller. As used in this paragraph, the term "Products" shall mean only Seller's standard hardware and software that are generally commercially available, and expressly excludes third-party-branded equipment/software. THIS PARAGRAPH IS IN LIEU OF ALL WARRANTIES OR REPRESENTATIONS, WHETHER EXPRESS OR IMPLIED, THAT THE PRODUCTS WILL BE FREE OF THE RIGHTFUL CLAIM OF ANY THIRD PARTY BY WAY OF INFRINGEMENT OR THE LIKE.

**5. RESALE OF THIRD-PARTY BRANDED PRODUCTS AND SERVICES.** NOTWITHSTANDING ANY OTHER PROVISION HEREIN, SELLER MAKES NO REPRESENTATIONS, PROVIDES NO INDEMNITIES (INTELLECTUAL PROPERTY OR OTHERWISE), AND DISCLAIMS ALL WARRANTIES OF ANY KIND, EXPRESS OR IMPLIED RELATIVE TO ANY THIRD-PARTY BRANDED PRODUCT OR SERVICE (INCLUDING TRAINING) WHICH MAY BE RESOLD OR SUBLICENSED BY SELLER AS A DISCRETE ITEM HEREUNDER.

**6. LICENSED SOFTWARE AND FIRMWARE.** Use of Products comprised of software or firmware may be subject to Buyer's acceptance of additional terms and conditions set forth in separate Seller or third-party license agreements that will control to the extent necessary to resolve any conflict with the terms and conditions stated or otherwise referenced herein. In the absence of a separate Seller's license agreement, Buyer is granted a non-exclusive, non-transferable license to use provided Seller's software or firmware only in object code form and solely in conjunction with Seller-provided Products, with no rights to sublicense, disclose, disassemble, decompile, reverse engineer, or otherwise modify the software or firmware.

**7. PACKING AND MARKING.** Buyer-specified packing or marking may be subject to additional charges not otherwise included in the price of the Products.

**8. WEIGHTS AND DIMENSIONS.** Published or advertised weights and dimensions are estimates or approximations only and are not warranted.

**9. PRICES.** Prices and other information shown in any Seller publication (including product catalogs and brochures) are subject to change without notice and to confirmation by specific quotation. Such publications are not offers to sell and are maintained only as a source of general information. Prices do not include sales, use, excise, customs, value-added or similar taxes. Buyer will pay or reimburse Seller for all such taxes as may be applicable. Time and material services will be provided in accordance with Seller's published service rates (including applicable overtime and travel expenses) in effect as of the date such services are provided, unless otherwise confirmed by Seller's written quotation or order acknowledgment. Billable service time includes travel time to and from the job site and all time Seller's representatives are available for work and waiting (whether on or off the job site) to perform the services.

**10. CHANGES AND SUBSTITUTIONS.** Buyer-requested order changes, including those affecting the identity, scope and delivery of the Products, must be documented in writing and are subject to Seller's prior approval and adjustments in price, scheduling and other affected terms and conditions. In any event, Seller reserves the right to reject any change that it deems unsafe, technically inadvisable or inconsistent with established engineering or quality guidelines and standards, or incompatible with Seller's design or manufacturing capabilities. Seller further reserves the right to substitute using the latest superseding revision or series or equivalent Product having comparable form, fit and function.

**11. RETURNS.** All returns of Products will be pursuant to Seller's instructions. Non-warranty returns of unused and resalable Products for credit will be subject to Seller's return policies in effect at the time, including applicable restocking charges and other conditions of return. Products returned under warranty must be properly packed and shipped to Seller-specified locations. Shipping containers must be clearly marked per Seller's instruction and shipped freight prepaid by Buyer. Notwithstanding the foregoing, all sales of "Open Box" Products and any third-party branded products are final and do not qualify for non-warranty return.

**12. ORDER CANCELLATION.** Cancellation by Buyer prior to shipment is permitted only by written notice and upon payment to Seller of reasonable cancellation and restocking charges, including reimbursement for direct costs. Cancellation charges associated with orders for custom Products or Products specifically manufactured to Buyer's specification may equal the actual selling price of the Products. Seller has the right to cancel an order for cause at any time by written notice, and Seller will be entitled to cancellation and restocking charges as identified above. No termination by Buyer for cause will be effective unless and until Seller has failed to correct such alleged cause within forty-five (45) days after receipt of Buyer's written notice specifying such cause.

**13. FORCE MAJEURE.** Seller will not be liable for any loss, damage or delay arising out of its failure (or that of its subcontractors) to perform hereunder due to causes beyond its reasonable control, including without limitation, acts of God, acts or omissions of Buyer, acts of civil or military authority, fires, strikes, floods, epidemics, quarantine restrictions, war, riots, acts of terrorism, delays in transportation, or transportation embargoes. In the event of such delay, Seller's performance date(s) will be extended for such length of time as may be reasonably necessary to compensate for the delay.

**14. DISPUTES.** The parties will attempt in good faith promptly to resolve any dispute arising hereunder by negotiations between representatives of the parties who have authority to settle the dispute. If unsuccessful, the parties further will attempt in good faith to settle the dispute by non-binding third-party mediation, with mediator fees and expenses apportioned equally to each side. Any dispute not so resolved by negotiation or mediation may then be submitted to a court of competent jurisdiction in accordance with the terms hereof. These procedures are the exclusive procedures for the resolution of all such disputes between the parties.

**15. GOVERNING LAW AND FORUM.** The agreement evidenced hereby and all disputes arising thereunder will be governed by and interpreted in accordance with the internal laws and will be subject to the exclusive jurisdiction of the courts of the state, province or other governmental jurisdiction in which Seller's principal place of business resides, but specifically excluding the provisions of the 1980 UN Convention on Contracts for the International Sales of Goods. Should any term or provision hereof be held wholly or partly invalid or unenforceable under applicable law, the remainder of the agreement evidenced hereby will not be affected thereby.

**16. ASSIGNMENT.** The agreement evidenced hereby may not be assigned by either party without the written consent of the other (which consent will not be unreasonably withheld). However, consent will not be required for internal transfers and assignments as between Seller and its parent company, subsidiaries or affiliates as part of a consolidation, merger or any other form of corporate reorganization.

**17. LANGUAGE.** The parties acknowledge that they have required that the agreement evidenced hereby be drawn up in English. Les parties reconnaissent avoir exigé la rédaction en anglais du Contrat. In the event of a conflict between the English and other language versions, the English version will prevail.



# 1. Getting Started

**Features of Promi-SD**

**Components**

**Assembly**

**Locating the Controls**

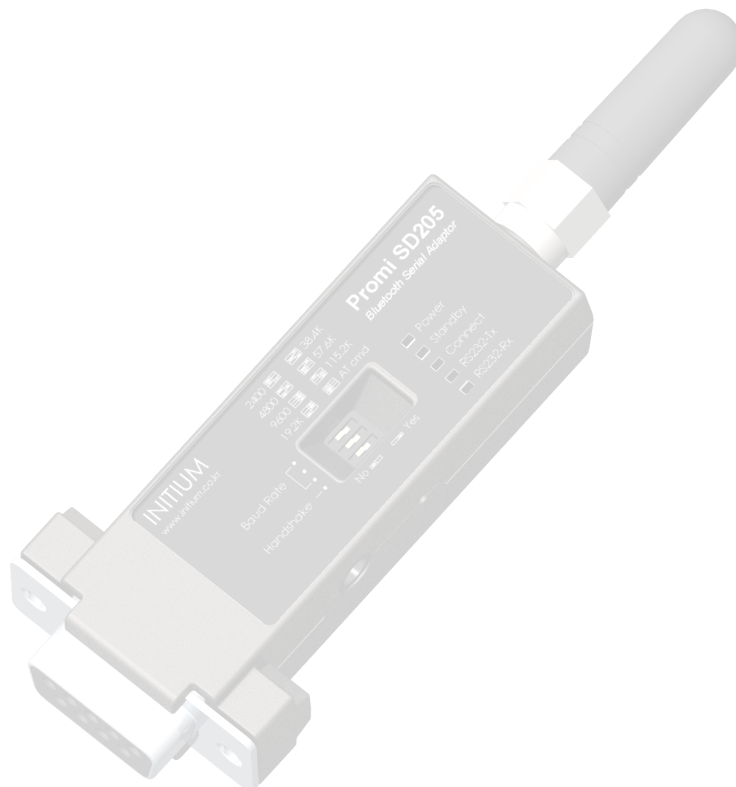

get **UNWIRED**, it's easy!

## Features of Promi-SD

### ↳ Reliability and Interoperability

Promi-SD is a terminal device for wireless serial communication using the Bluetooth technology that is international standard of short range wireless communications. Promi-SD accomplishes more reliable wireless communication. As Promi-SD can communicate with other Bluetooth devices, user may construct various communications with it.

Promi-SD 202/205 OA provides wireless communication with communication range up to 100m (Promi-SD202, 205) for user's various applications. In terms of noise, Promi-SD delivers better quality of communication than standard RS232 cables.

### ↳ Compact Design

Promi-SD has the most compact design of the same kind devices and can be placed conveniently into any devices or equipments. Its detachable antenna of variety optimizes the quality and distance of wireless communications.

### ↳ Easy Configuration and Adaptation

Promi-SD can be configured and controlled by typical AT commands. User can easily configure Promi-SD on the terminal program such as HyperTerminal and implements the wireless communication without modifying user's existing serial communication program. In addition to the basic AT commands, Promi-SD provides some expanded AT commands for its various functions.

User friendly PromiWizard and PromiWIN are also provided for easy setup on Microsoft Windows.

For Promi-SD205, user can setup the serial port parameters by dip switch without PC.

### ↳ Security

The FHSS (Frequency Hopping Spread Spectrum) technique of Bluetooth lets Promi-SD have less radio interference and no danger of hacking in air. Promi-SD also supports authentication and data encryption.

### ↳ Benefits

- No cable installation
- Free from the environmental limitations
- Easy relocation
- Simple maintenance

## Components

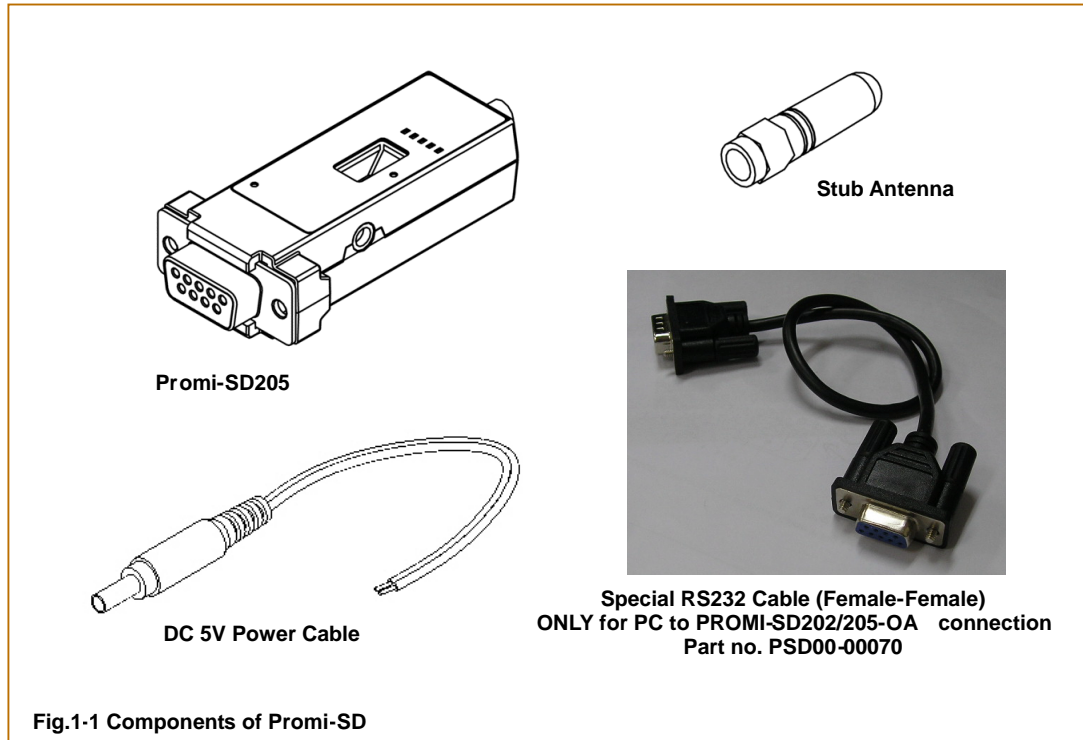

Please check the components of Promi-SD in Fig. 1-1 when purchasing. The picture of product may differ by models. The components of the package may change for improving product capacity or quality without notice.

## Assembly

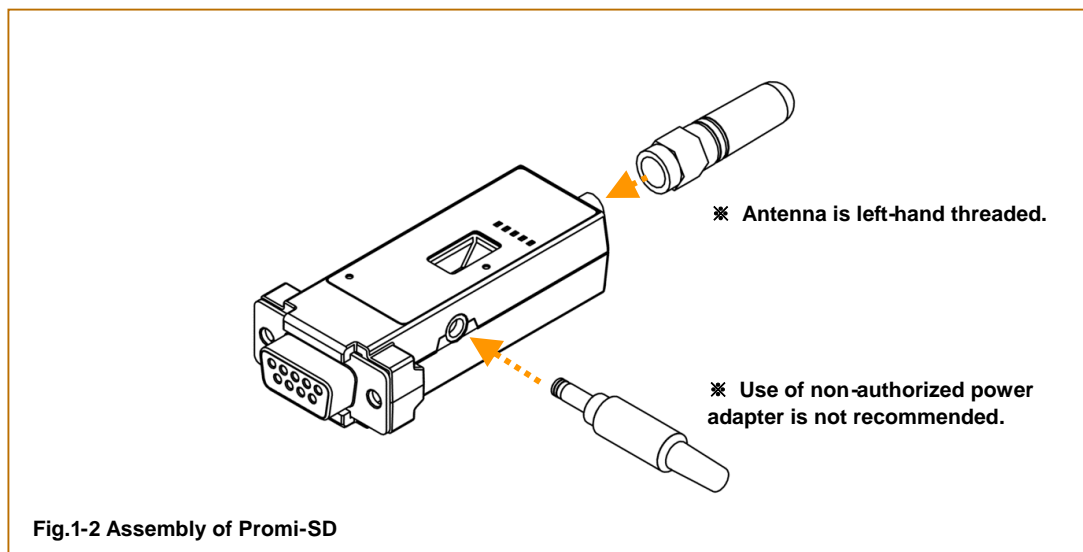

## Locating the Controls

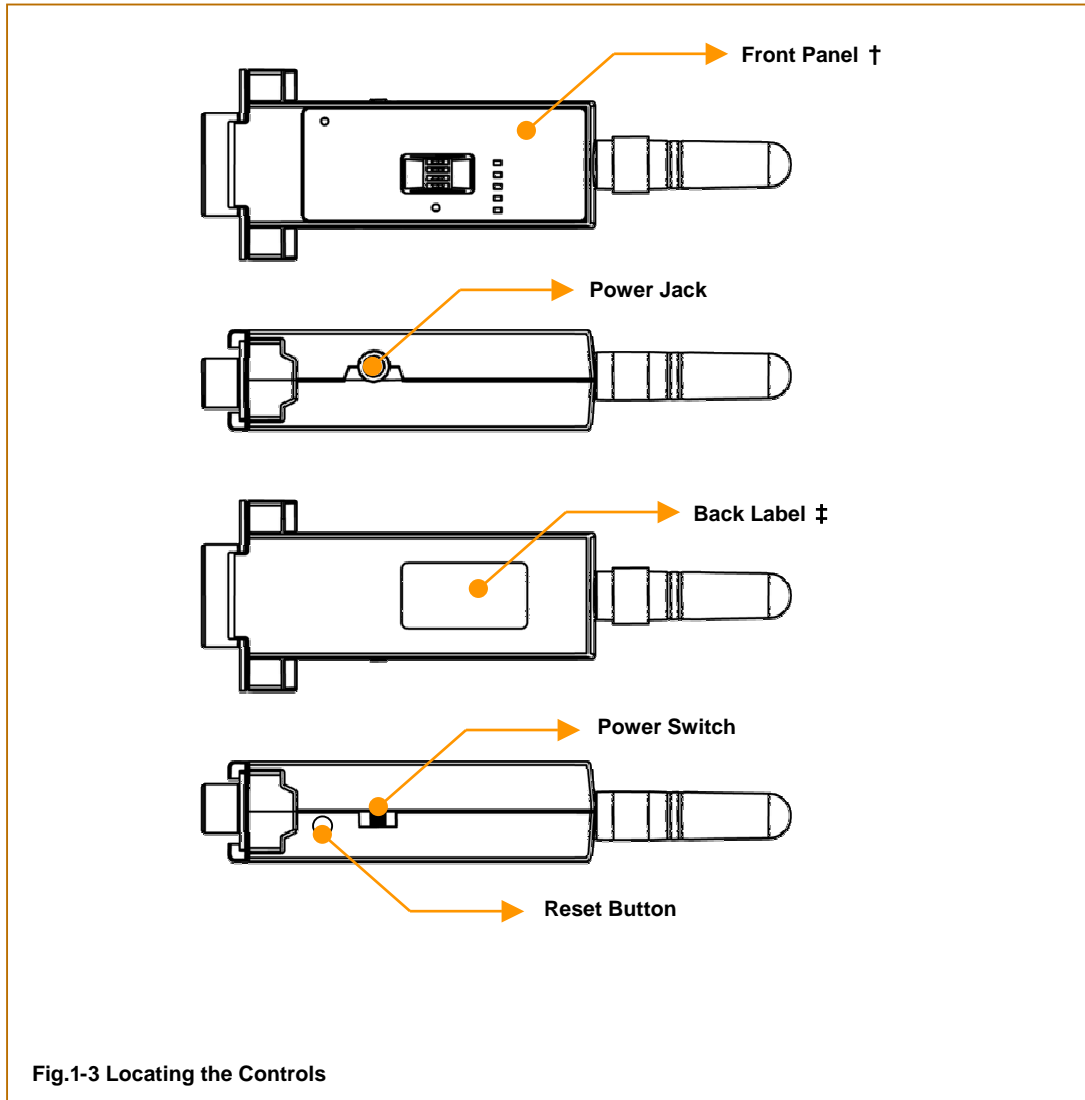

↘

### ↘ Front Panel †

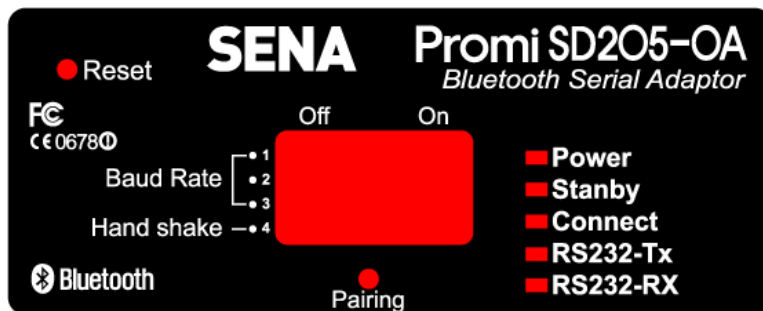



## 2. Configurations

**Operation Modes**

**LED Indicators**

**Serial Ports**

**Reset to Factory Defaults**

**PromiWizard™**

**PromiWIN™**

**Terminal Program**

**Dip Switch**

**Pairing Button**

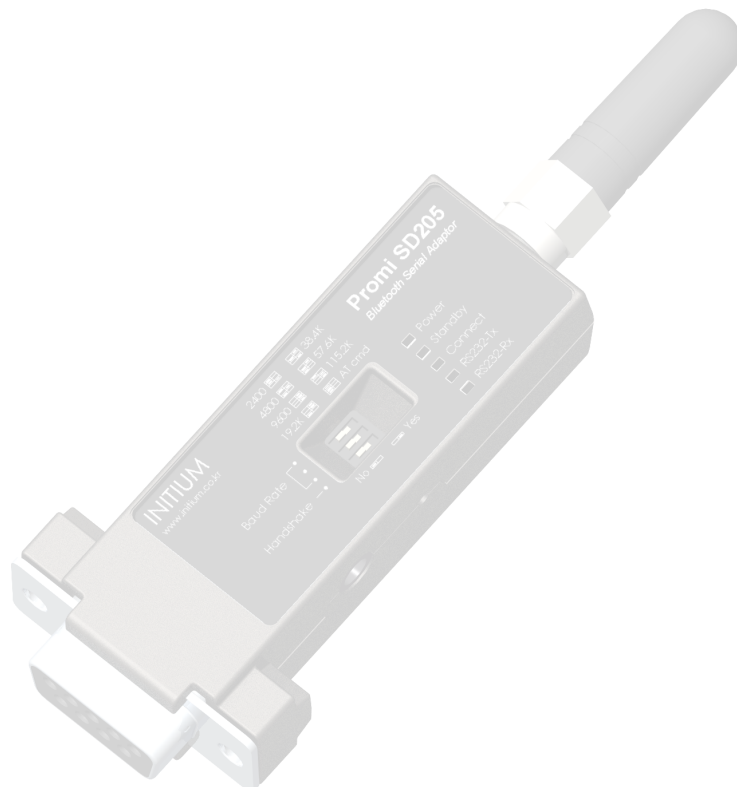

get **UNWIRED**, it's easy!

## Operation Modes

In addition to the serial port configurations such as bit/second, data bit, parity, stop bit, flow control, Promi-SD has some configurations for Bluetooth. For getting the most out of Promi-SD, user should understand the following Bluetooth connection schemes.

A Bluetooth device can play a role as a master or slave. Master tries to connect itself to other Bluetooth device, and slave is waiting to be connected from other Bluetooth devices. A Bluetooth connection is always made by a pair of master and slave. A slave can be in two modes, Inquiry Scan or Page Scan mode. Inquiry Scan mode is waiting the packet of inquiry from other Bluetooth devices and Page Scan mode is waiting the packet of connection from other Bluetooth devices. Every Bluetooth device has its unique address, called BD (Bluetooth Device) address, which is composed of 12 hexa-decimal numbers.

Promi-SD has 4 operation modes as follows. Each mode can be identified with LED indicators as illustrated in next section.

### ↳ **Mode0**

Promi-SD must be in Mode0, when it is directly controlled by AT commands.

In this mode, there is no response when power on or software reset, and Promi-SD is just waiting for AT command input. Neither master nor slave is assigned to Promi-SD in mode0. User can change the configurations of Promi-SD in this mode.

The factory default is set to Mode0.

### ↳ **Mode1**

Promi-SD tries to connect the last connected Bluetooth device.

Promi-SD in Mode1 is to be a master and tries to connect the last connected Bluetooth device. Promi-SD always stores the BD address of the Bluetooth device to which Promi-SD has connected last time. When Promi-SD is initially used or after hardware reset, there is no BD address stored in Promi-SD. In this case, Mode1 does not make any sense and mode change from other operation modes to Mode1 is not allowed. The mode change to Mode1 can be made after Promi-SD succeeds to connect to other Bluetooth device in Mode0. Once changed to Mode1, Promi-SD will try to connect automatically the last connected Bluetooth device whenever power on or software reset.

Promi-SD in Mode1 cannot be discovered or connected by other Bluetooth devices.

### ↳ **Mode2**

Promi-SD is waiting for the connection from the last connected Bluetooth device.

Promi-SD in Mode2 is to be a slave and waiting for the connection only from the last connected Bluetooth device. Just like Mode1, if there is no BD address stored in Promi-SD, the mode change from other operation modes to Mode2 is not allowed. Once changed to Mode2, Promi-SD will wait for the connection from the last connected Bluetooth device whenever power on or software reset.

Promi-SD in Mode2 cannot be discovered or connected to Bluetooth devices other than the last connected device.

### ↳ **Mode3**

Promi-SD is waiting for the connection from any other Bluetooth devices.

Promi-SD in Mode3 acts like in Mode2, but allows any connection from other Bluetooth device. Most of general Bluetooth device is set to Mode3.

Promi-SD in Mode3 can be discovered and connected from any other Bluetooth devices.

## LED Indicators

Indicator	Power LED	Standby LED	Connect LED
Mode0	Green	Red	
Mode1	Green		Green (every 1 sec)
Mode2	Green		Green (every 3 sec)
Mode3	Green		Green (every 3 sec)
Connected	Green		Green

RS232-Tx and RS232-Rx LED are blinking accordingly when data is transmitted. For small data transmission, it may be hard to recognize the quick blinking.

## Serial Ports

The applicable settings for serial ports are as follows.

Serial Port Settings	Values
Baud rate	1200, 2400, 4800, <span style="border: 1px solid black; padding: 2px;">9600</span> , 19200, 38400, 57600, 115200, 230400
Data bit	<span style="border: 1px solid black; padding: 2px;">8</span>
Parity	<span style="border: 1px solid black; padding: 2px;">No parity</span> , Even parity, Odd parity
Stop bit	<span style="border: 1px solid black; padding: 2px;">1</span> , 2
Hardware Flow Control	No use

The values in box are the factory defaults.

### ➤ Data Bit

Promi-SD supports only 8 data bit. In the case of 7 data bit, please contact the technical support.

## Reset to Factory Defaults

To turn back all the configurations to its factory settings, press the reset button depicted in Fig. 1-3. Press the reset button with a narrow pointed tool like paper clip longer than 1 second. Reset works only when power is on.

## Dip Switch (Promi-SD205 OA)

This feature is only on Promi-SD205 OA. With the combination of 4 slot dip switches, baud rate can be set simply without host computer.

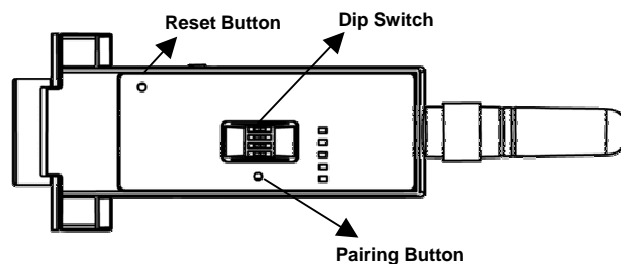



Upper 3 dip switches are used for setting baud rate. If the baud rate needs to be set out of the range given below, PromiWIN or terminal program should be used for extended AT commands. At this time combination of dip switches must be complied with AT cmd. Then baud rate will go back to 9600 as default.

Baud Rate	2400	4800	9600	19.2K	38.4K	57.6K	115.2K	AT cmd

Hardware Flow Control Handshaking	No use	No use

## Pairing Button

Promi-SD205-OA provides Pairing Button for instant configuration without PC to make an automatic connection between two Promi-SDs. For convenience sake, name two Promi-SDs as SD1 and SD2 respectively.

Turn off all the nearby Promi-SD

Turn on SD1 and SD2 and hardware reset both of them by pressing Reset Button.

Press the Pairing Button of SD1 for 2 seconds until Standby LED turns off and Connect LED blinks 3 times every 2 seconds. Keep the power ON.

Press the Pairing Button of SD2 for 2 seconds until Standby LED turns off and Connect LED blinks 3 times every 2 seconds. Now press again the Pairing Button for 2 seconds until Connect LED blinks every 0.5 second.

Wait for SD1 & SD2 to be connected for a while until Connect LED's of SD1 and SD2 is lit in green. It takes about 10 seconds to make a connection. If there are many Bluetooth devices nearby, it will take a little bit more.

Turn SD1 off and on. Connect LED blinks twice in green every 3 seconds.

Turn SD2 off and on. Connect LED blinks once in green every 1 second.

Now a pair of Promi-SD is configured to make automatic connection, whenever power off and on.

Just use this pair of Promi-SD like virtual serial cable.

\* Note: While pairing is progressing through the pairing buttons, the Command Response doesn't operate automatically. Then, the response messages such as OK, Connect, Disconnect and so on are not sent by Promi-SD.

SD 1	status	LED	SD 2	status	LED
1. hard reset	Mode0	Standby LED turn on.	1. hard reset	Mode0	Standby LED turn on.
2. push pairing button	Mode3	Connect LED blinks 3 times every 2 sec.	2. push pairing button	Mode3	Connect LED blinks 3 times every 2 sec.
3.			3. push pairing button again	Mode1	Connect LED blinks every 0.5 sec.
4. connected	Slave	Connect LED is lit in green	4. connected	Master	Connect LED is lit in green

## Configuration Software

Configuration Software	Usage	Operating Platform
PromiWIN	Individual setup of Promi-SD	MS Windows 98SE or higher
PromiUpdater	Firmware Update	MS Windows 98SE or higher

This configuration software comes with the product, which also can be downloaded from <http://www.sena.com>

## PromiWIN

PromiWIN is a program running on Microsoft Windows for the configuration of Promi-SD. Install PromiWIN on your computer. Plug a Promi-SD into the serial port of the computer and turn on the power. Run PromiWIN.

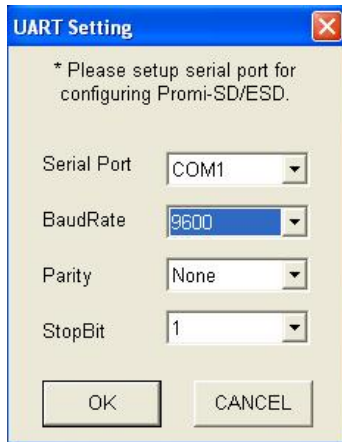

Set each option properly and click [Confirm]. If the settings are different from the host computer, error message will pop up. If the Promi-SD is in the status of connection, warning message will pop up. Then the current connection can be cancelled by [Disconnect] button on the main window.

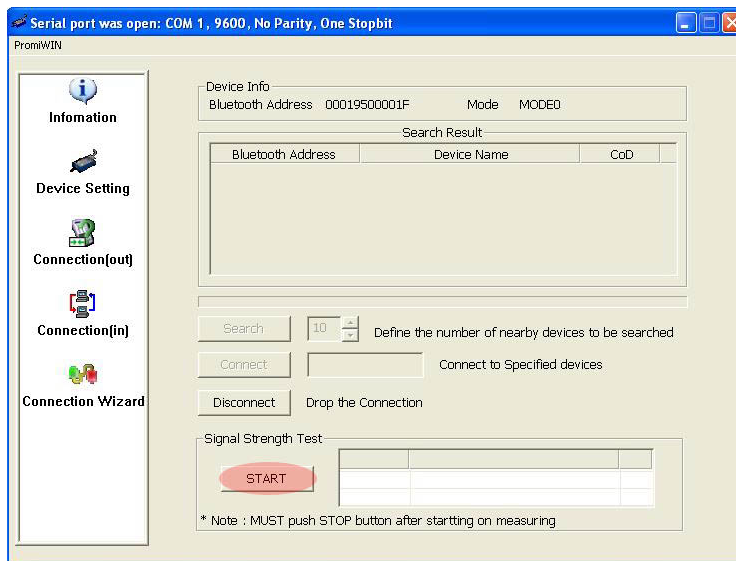



Serial port settings can be changed by <Start Configuration> and <PromiWIN Configuration> of PromiWIN in the menu bar at upper left corner of the window without re-running the PromiWIN program.



The icons in the left side window come to the corresponding windows.

In device configuration window, hardware reset can be executed or operation mode and RS232 can be configured as well. Security option also can be configured in this window.

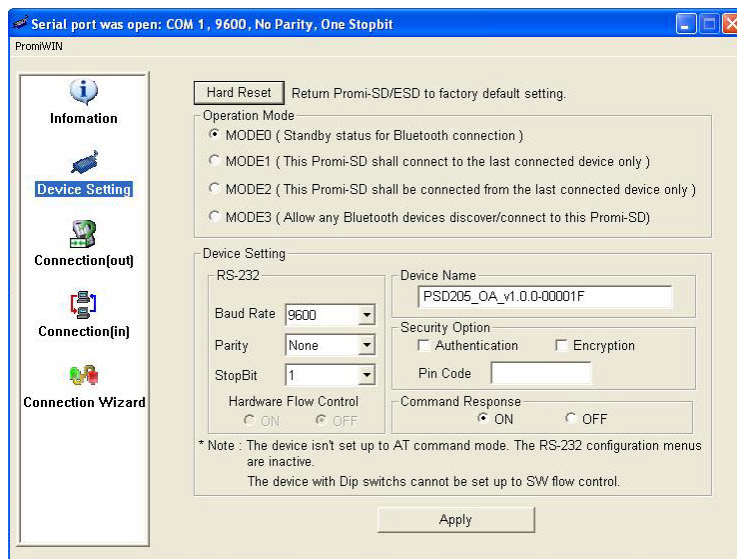

Promi-SD supports two security options, Authentication and Encryption. If you check the Authentication option, you must also enter the Pin Code value. If the authentication is activated, the connection, only between the Master and Slave device that share the same Pin Code, is established. In case that Promi-SD connects to other Bluetooth device, you must enter the other device's Pin Code in Promi-SD. In general Bluetooth devices, 1234 or 0000 is used as a default value. If you check Encryption option, the Promi-SD encrypts packets and sends them. The Encryption options works well in case that only one between Master and Slave uses this option.

Promi-SD has 4 response messages, 'OK', 'ERROR', 'CONNECT', and 'DISCONNECT'. In some cases, these responses can affect the host system unexpectedly. To prevent this, user can set the Command response to ON or OFF.

For Promi-SD205 OA pin 4 and pin 5 are connected in the hardware to disable hardware flowcontrol. Thus H/W Flow Control option will not work in this case. When the dip switch value isn't ATcommand mode, the RS-232 menu is disabled.

Click [Apply] button to reflect the given options to Promi-SD actually.

Connect(out) icon will show the following window to search and connect other Bluetooth devices.

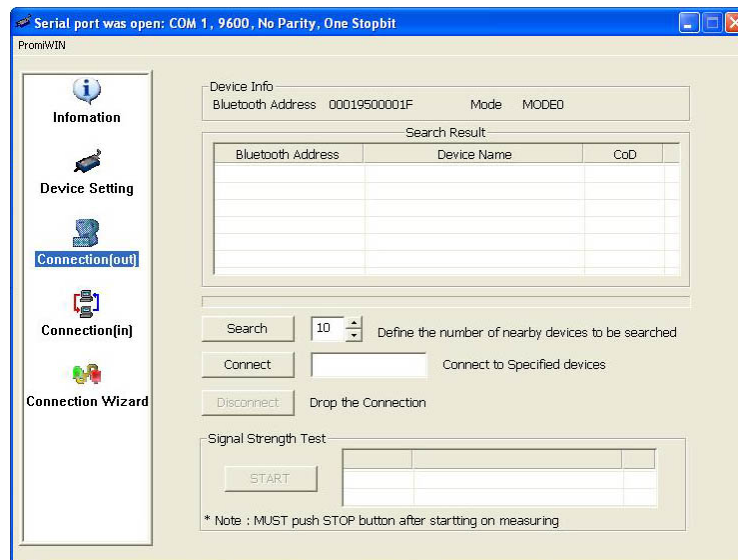

Click [Search] button to search nearby Bluetooth devices. The maximum number of devices to be searched can be controlled. Select one of the devices searched and click [Connect] button. The selected Bluetooth device must be in Page scan mode. Click [Disconnect] button to cancel the connection normally.

After the connection is established, you can test sensitivity through the START button.

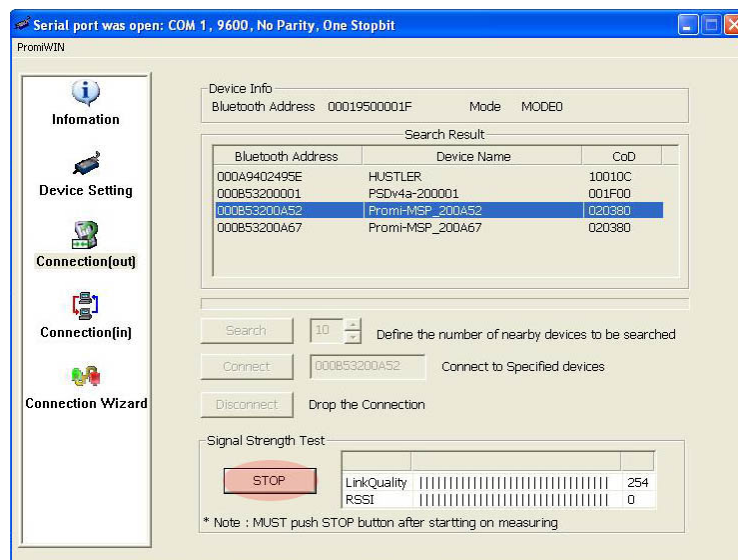

The sensitivity test shows LinkQuality and RSSI values. If the LinkQuality approaches to 255 and RSSI approaches to 0, the sensitivity is good. In general, when the distance is 10 meters, the sensitivity is the best. You can push the STOP button in order to terminate the sensitivity test. The sensitivity test will continue until the STOP button is pushed. If you close the the PromiWin without pushing the STOP button, you must restart SD to terminate the test.

Connection(in) icon will show the following window to make Promi-SD wait to a connection from the other Bluetooth device. The waiting time in seconds can be controlled. With 0 input for this waiting time, Promi-SD keeps waiting for connection until [Cancel] button is clicked.

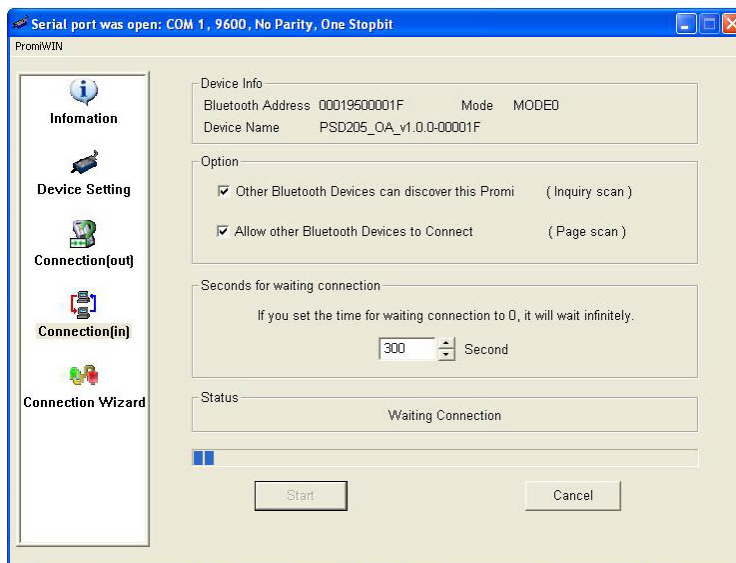

If the Connection Wizard icon is clicked, an easy pairing menu to use appears as follows:

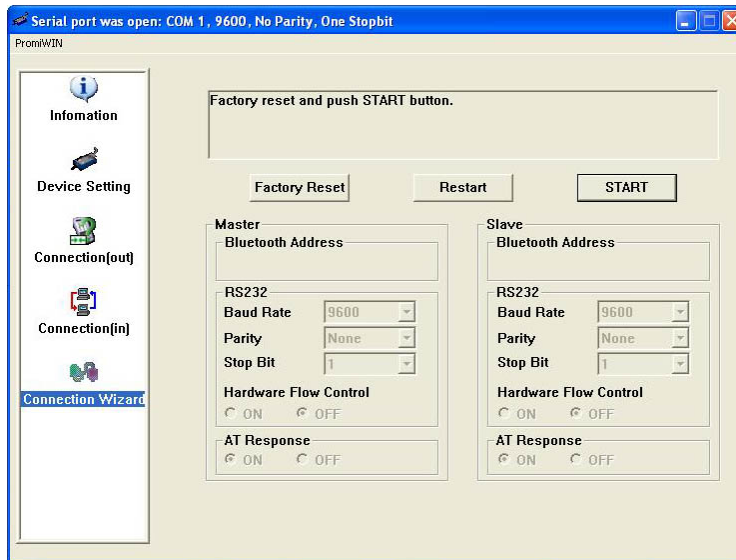

This menu help pairing configuration of Promi-ESD that hasn't pairing button. Although this menu can be used to pairing configuration of Promi-SD that has pairing button, pairing configuration through pairing button is recommended. To use this menu, follow next steps.

1. Connect the first SD and then push the START button.
2. Disconnect the first SD, connect the second ESD and then push the Next button after setting up Slave configuration. At this time, the dip switch value should be ATcommand mode.
3. Disconnect the second SD, once again connect the first ESD and then push the Finish button. The pairing configuration finished. Make sure that each SD's connect LED is on. From now, when the SD restarts the pairing connection will be established automatically.

## PromiUpdater

Promi-SD supports firmware updates. You can download new firmware images for the Promi-SD at <http://www.sena.com>. With the PromiUpdater, you can update the firmware of Promi-SD by selecting the firmware image file and pushing Start button.

\* Note: DO NOT power off Promi-SD while the firmware update is progressing, this may damage the Promi-SD.

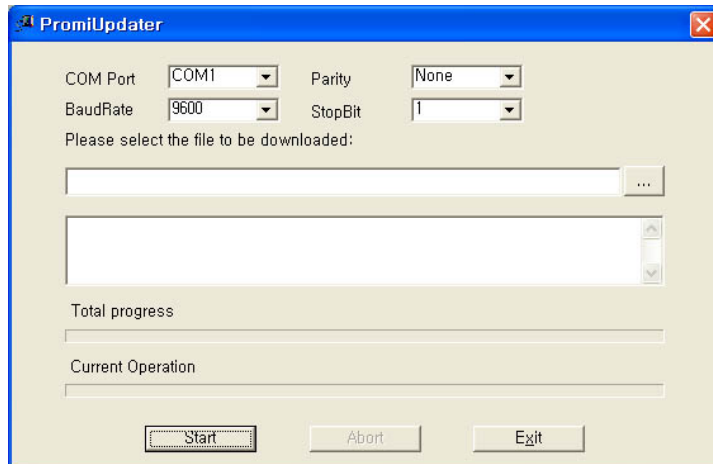

## Terminal Program

A terminal program is an application that will enable a PC to communicate directly with a modem. If you are using Windows 98SE or higher version of Windows, HyperTerminal program as it is included as part of the operating system. Promi-SD provides some extended AT commands for its configurations on terminal program.

This manual will explain the method using HyperTerminal. If you need to install HyperTerminal, click start>setting>control panel>add/remove programs. For more precise information, please refer to Help of Microsoft Windows.

Attach Promi-SD to serial port of PLC and power on. Check Status LED (Promi-SD202/205 OA) or Standby LED (Promi-SD205) is lit in green.

Launch HyperTerminal. It can be found in start >programs >accessories >communication >HyperTerminal. Select the Serial port that Promi-SD will be connected to.

Input the same settings into Serial port configuration window as Promi-SD settings.

The settings need to be set correctly, otherwise, error message may be shown up on the screen or cause malfunctioning of Promi-SD.

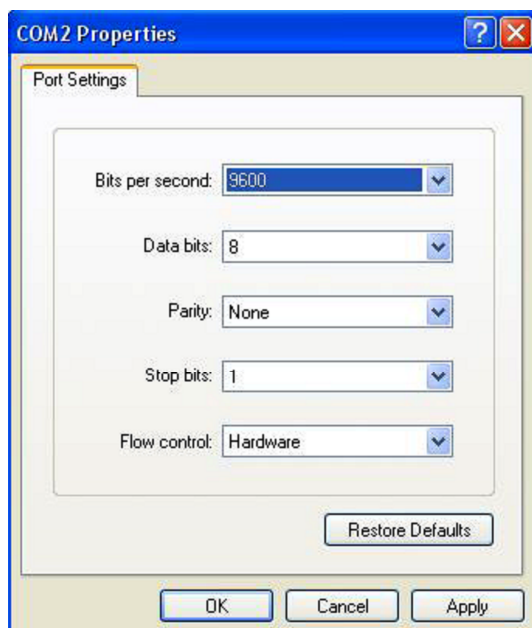

Choose the settings in File->Properties->Settings->ASCII setup that let you turn echo on in HyperTerminal; this will show the response Promi-SD sends on the screen.

You now get the HyperTerminal window where you are able to control Promi-SD with AT commands. For expanded AT commands that Promi-SD provides, please refer to Appendix A. AT commands.

Example of AT commands:

```
AT+BTINFO?  
000B53000509,PSDv3b-000509,MODE0,STANDBY,0,0,HWFC  
  
OK  
AT+BTINQ?  
000B5320007E,PSDv2a-20007E,001F00  
  
0004B300E205,AP2002:1 #0,020300  
  
OK  
ATD000B53000509  
OK  
  
CONNECT 000B53000509
```

## 3. Connections

**RS232 Interface**

**Pin Assignment**

**Power Supply**

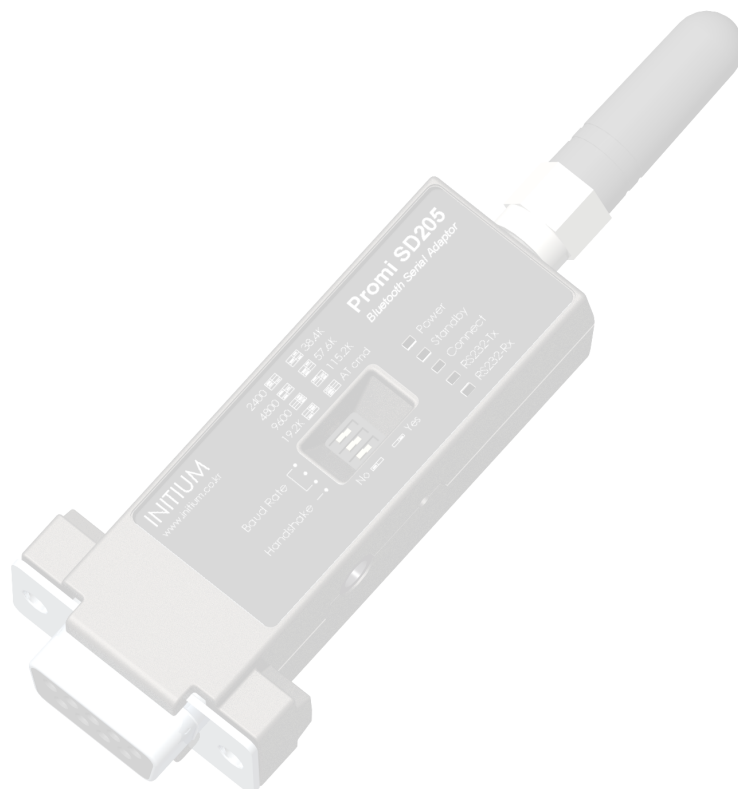

get **UNWIRED**, it's easy!



## RS232C Interface

### RS232C

In the early 1960s, a standards committee, today known as the Electronic Industries Association, developed a common interface standard for data communications equipment. At that time, data communications was thought to mean digital data exchange between a centrally located mainframe computer and a remote computer terminal, or possibly between two terminals without a computer involved. These devices were linked by telephone voice lines, and consequently required a modem at each end for signal translation. While simple in concept, the many opportunities for data error that occur when transmitting data through an analog channel require a relatively complex design. It was thought that a standard was needed first to ensure reliable communication, and second to enable the interconnection of equipment produced by different manufacturers, thereby fostering the benefits of mass production and competition. From these ideas, the RS232 standard was born. It specified signal voltages, signal timing, signal function, a protocol for information exchange, and mechanical connectors. Refer the following site for details;

[http://www.camiresearch.com/Data\\_Com\\_Basics/RS232\\_standard.html](http://www.camiresearch.com/Data_Com_Basics/RS232_standard.html)

### DTE/DCE

If the full EIA232 standard is implemented as defined, the equipment at the far end of the connection is named the DTE device (Data Terminal Equipment, usually a computer or terminal), has a male DB9 connector. Equipment at the near end of the connection (the telephone line interface) is named the DCE device (Data Circuit-terminating Equipment, usually a modem), has a female DB9 connector. The cable linking DTE and DCE devices is a parallel straight-through cable with no cross-overs or self-connects in the connector hoods. If all devices exactly followed this standard, all cables would be identical, and there would be no chance that an incorrectly wired cable could be used.

### DB9 Male

Promi-SD is a DCE device compatible with RS232 standard, having DB9 male interface.

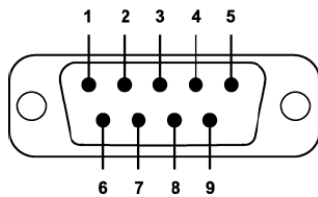

## Pin Assignment

Pin #	Signal	Direction	Description
1	N/A	-	
2	RxD	Input	Received Data
3	TxD	Output	Transmitted Data
4	N/A	-	
5	N/A	-	
6	Vcc	Input	Ring Indicator
7	N/A	-	
8	N/A	-	
9	GND	-	Signal Ground

## Power Supply

Promi-SD can be supplied power through the power jack and through pin 6 of DB9 connector.

### ↳ Through Power Jack

DC 5 ~ 12V, Min. 150mA power should be supplied through DC power cable. Red cable is positive and black one is negative.



Electrical Polarity

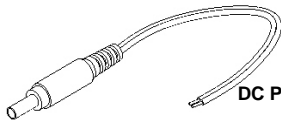

DC Power Cable

Red +  
Black -

AC/DC power adaptor and USB power cable are also available to supply power.

AC/DC Power Adapter

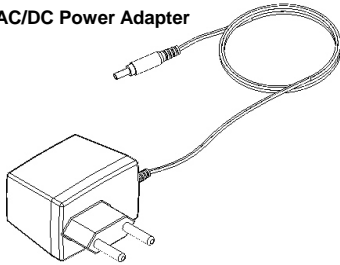

USB Power Cable

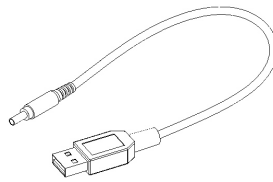

### ↳ Through Pin 9 of DB9 connector

The power can be supplied through pin 9 of DB9 connector. Because Promi-SD does not have any protection circuit from surge, it must be constant voltage of 5 ~ 12V. Because SD have a Reset-Chip, when the power is not adequate SD will restart.



Special RS232 Cable (Female-Female)

[ONLY for PC to PROMI-SD202-OA and PROMI-SD205-OA connection](#)

Part no. PSD00-00070

## 4. Trouble Shooting

**No Data Transmission**

**Data Loss or Malfunctioning**

**Transmission Delay**

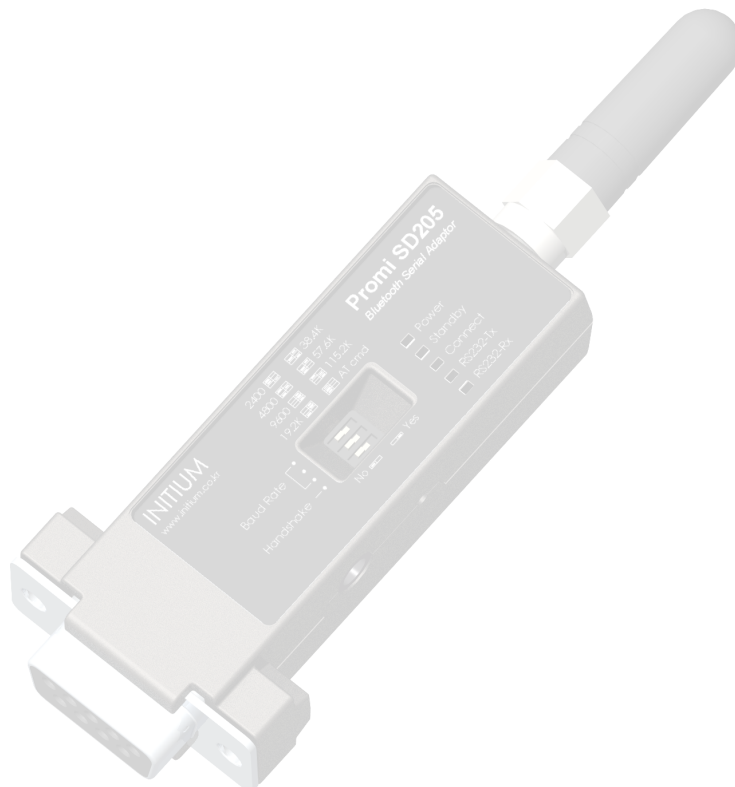

get **UNWIRED**, it's easy!

## No Data Transmission

### ↘ COM Port Settings

Check whether the Baud rate of Promi-SD is same as that of its host equipment. If you do not know the current Baud rate of Promi-SD, initialize it to 9600 by pressing Reset Button. Note that in case of SD the baudrate setting does not change after reset.

Check whether the Data bit is set to 8. Promi-SD supports only 8 Data bit. If your host equipment uses 7 Data bit and even or odd parity, it can work as if it uses 8 Data bit and No parity. This is valid only when both DCE devices are Promi-SD. In this case, set both Promi-SDs to 8 Data bit and No parity. If one of DCE devices is other Bluetooth device such as Bluetooth USB dongle, please contact Technical Support.

Check whether the Parity and Stop bit of Promi-SD are same as those of its host equipment. Promi-SD supports No parity, Even parity and Odd parity, 1 and 2 Stop bit.

Promi-SD does not support RS-232 break signal.

### ↘ Pin Assignment

Promi-SD is DCE device. If your host equipment is DTE, plug Promi-SD directly to the host equipment or use straight RS-232 cable. If your host equipment is DCE, use cross over RS-232 cable (Null modem cable).

## Data Loss or Malfunctioning

### ↘ Hardware Flow Control

When transmitting large data with No use of Hardware Flow Control, Promi-SD will clear the data buffer unexpectedly. This possibility goes higher as the RF transmission environment is bad.

### ↘ SD Response

The messages of SD response may affect the function of host system. Set AT\$10=0 not to send SD response to host system and try again. Refer Appendix B. for details.

## Transmission Delay

### ↘ RF Processing Delay

It takes 30msec approximately for a Promi-SD to complete the data transmission to the other side Bluetooth device. This time delay cannot be reduced and would be bigger as the RF transmission environment is bad. Do not use Promi-SD If your applications cannot allow this time delay.

### ↘ RF Transmission Environment

If there are lots of Bluetooth device working in a small area and/or the RF communication distance is too long and/or there are some obstacles affecting RF performance, Promi-SD repeats the transmission packet by packet due to interferences and/or low RF performance. This leads the transmission time delay.

## 5. Specifications

**Bluetooth Interface**

**Serial Interface**

**Power**

**Mechanical Dimensions**

**Environmental**

**Default Antenna**

**Power Consumption**

**Wireless Coverage**

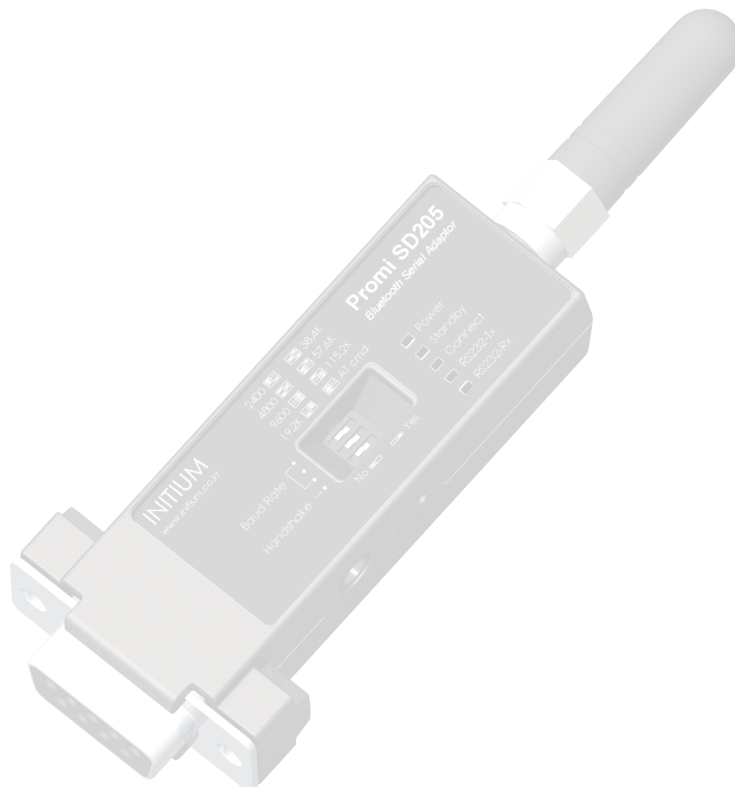

get **UNWIRED**, it's easy!

### ↳ Bluetooth Interface

- Bluetooth 1.2 specification compatible and qualified
- Protocol: RFCOMM, L2CAP, SDP
- Profiles: Serial Port Profile, Generic Access Profile, Service Discovery Profile
- Radio Frequency: 2.4 ~ 2.4738GHz
- Number of Channels: 79
- Transmission Power Class 2 (Promi-SD200)
- Data Transmission Rate: 380Kbps Max.

### ↳ Serial Interface

- EIA RS232C Standard
- Connector: DB9 female
- Data Transmission Rate: 1,200 ~ 230,400bps
- Hardware Flow Control: Off

### ↳ Power

- DC 5 ~ 12V Constant Voltage
- Supply: DC Jack or Pin 6 of DB9

### ↳ Mechanical Dimensions

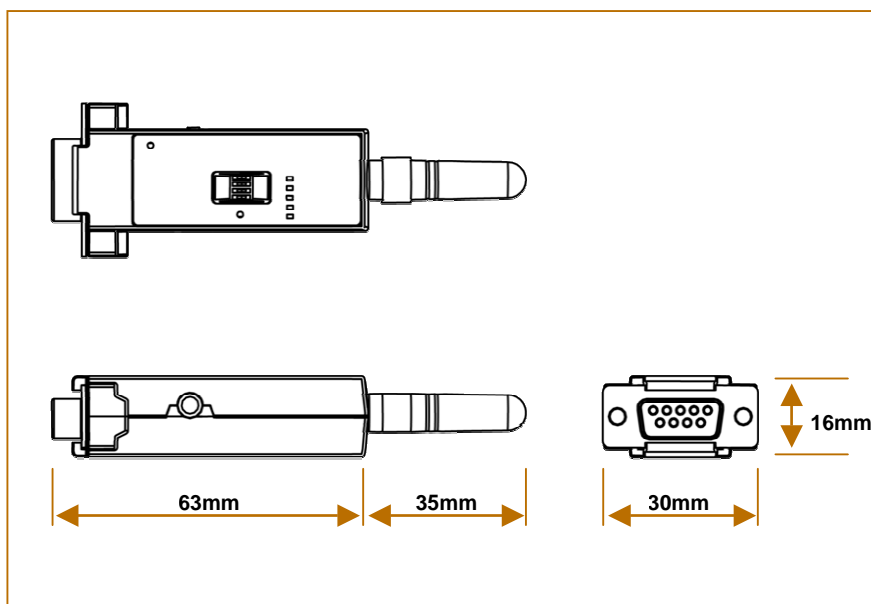

### ↳ Environmental

- Recommended Operational Temperature: -20°C ~ 70°C
- Recommended Operational Humidity: 90% Max. Non-condensing

### ▾ Default Antenna

- Type: Helical
- Frequency: 2,400 ~ 2,485GHz
- Gain: Max. 1dBi  $\pm$  1
- Impedance: 50 $\Omega$
- size: 30mm $\times$ 9mm (W $\times$ D)
- weight: 3.5g

### ▾ Power Consumption

The power consumption varies according to the operation status of Promi-SD. The table below shows the average measuring results in different operation modes with 1m communication distance.

Operation Status	Consumption Promi-SD205 OA
Not plugged into Serial port	17mA
Plugged into Serial port	31mA
Inquiry Scan	106mA
Page Scan	106mA
Inquiry & Page Scan	64mA
Connected as Master device	60mA
Connected as Slave device	37mA
Connected in Park mode as Master device	33mA
Connected in Park mode as Slave device	32mA
Connected and Transmitting Data at 9600bps	66mA
Connected and Transmitting Data at 115200bps	80mA

The power consumption will be increased as the communication distance is getting longer, but never exceeds 106 mA in any case.

### ▾ Wireless Coverage

The table below shows the average measuring results in open space. These results can vary according to the environmental conditions.

Antennas for two Promi-SD units	Maximum Distance (SD205 OA)
Stub Antenna – Stub Antenna	100m
Stub Antenna - Dipole Antenna	150m
Dipole Antenna - Dipole Antenna	200m
Patch Antenna - Dipole Antenna	400m
Patch Antenna - Patch Antenna	1,000m

# Appendix A. AT Commands

**Terminology**

**Command Category**

**Command Description**

**Command Validity**

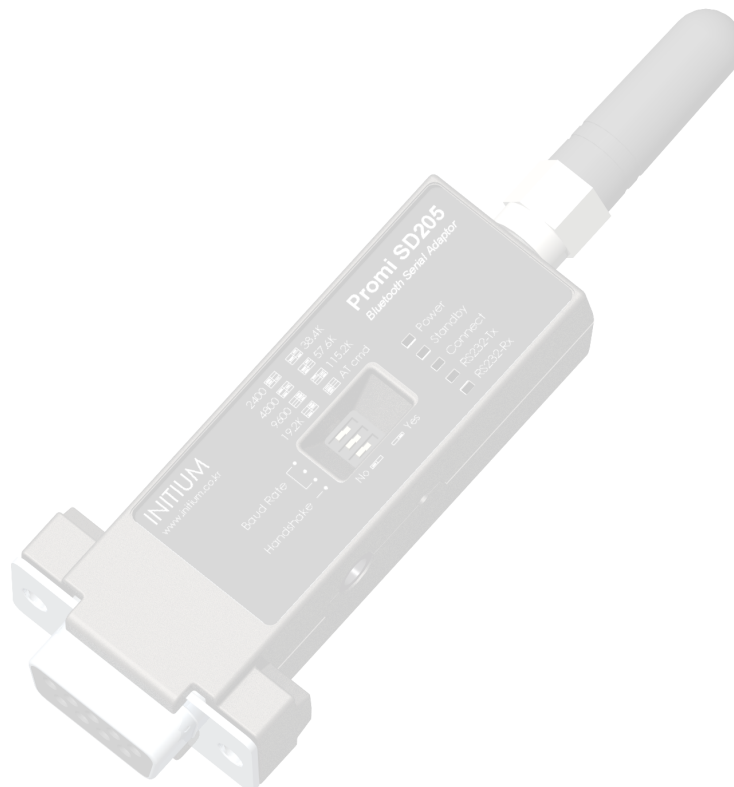

get **UNWIRED**, it's easy!



## Terminology

### ↘ AT Command

AT command set is the de facto standard language for controlling modems. The AT command set was developed by Hayes and is recognized by virtually all personal computer modems. Promi-SD provides the extended AT command set to control and configure the serial parameters and Bluetooth connection.

### ↘ AT Response

Promi-SD replies to AT commands with 4 kinds of message, 'OK', 'ERROR', 'CONNECT' and 'DISCONNECT'.

### ↘ Operation Mode

- Mode0: Waiting for AT commands
- Mode1: Attempting to connect to the last connected Bluetooth device
- Mode2: Waiting for the connection from the last connected Bluetooth device
- Mode3: Waiting for the connection from any other Bluetooth devices

### ↘ Operation Status

- Standby: Waiting for AT commands
- Pending: Executing tasks
- Connect: Transmitting data

### ↘ Security

- Authentication: Pin code (or Pass key)
- Encryption: Data encryption

### ↘ Symbols

The symbols are used for the description of command syntax as follows:

Symbol	Meaning	ASCII Code
↵	Carriage return	0x0D
↵	Line feed	0x0A
↵↵	Carriage return + Line feed	
112233445566	Bluetooth device address	
n or m	One digit decimal number	
to	Timeout in second	

## Command Category

Command Category	Index	AT commands	
RESET	1	ATZ	
	2	AT&F	
SERIAL PORT	3	AT	
	4	AT+UARTCONFIG,b,p,s	
	5	AT+USEDIP?	
BLUETOOTH	Information	6	AT+BTINFO?
		7	AT+BTINQ?
		8	AT+BTLAST?
		9	AT+BTVER?
		10	AT+BTRSSI,n
		Mode	11
	Status	12	+++
		13	AT+SETESC,nn
		14	ATO
		15	AT+BTCANCEL
		16	AT+BTSCAN
		17	AT+BTSCAN,n,to
		18	AT+BTSCAN1 2233445566,to
		Connection	19
	20		ATD1 2233445566
	21		ATH
	Security	22	AT+BTKEY=\$string
		23	AT+BTSD?
		24	AT+BTCSD
		25	AT+BTFP,n
		26	AT+BTSEC,a,e
	Miscellaneous	27	AT+BTNAME=\$string
		28	AT+BTLPM,n
	Firmware Update	29	AT+DFU
	S-REGISTER	30	AT&V
		31	ATSnn?
		32	ATSnn=mm

## Command Description

### 1 ATZ↵

SD Response	↵OK↵
Purpose	Software Reset
Description	This is the same effect as power off and on. This command disconnects Bluetooth device, and stops ongoing task. After rebooting, the status is decided by the preset operation mode. Some AT commands need ATZ to take effect.
Reference	AT&F, AT+BTCSD, AT+UARTCONFIG

### 2 AT&F↵

SD Response	↵OK↵
Purpose	Hardware reset
Description	This is the same effect as initialization by reset button. All parameters are initialized to factory defaults. The storage of Promi-SD is cleared completely.
Reference	ATZ

### 3 AT↵

SD Response	↵OK↵
Purpose	Check the connection status with host equipment
Description	Check if the connection to host equipment is normal. The serial parameters of Promi-SD must be same as those of host equipment. If not, SD response is none or 'ERROR' or abnormal sequence of strings.
Reference	AT+UARTCONFIG, ATZ, AT&F

### 4 AT+UARTCONFIG,Baudrate,Parity,Stopbit

SD Response	↵OK↵
Purpose	Set Serial parameters
Parameters	<i>Baudrate</i> =1200/2400/9600/14400/19200/38400/57600/115200/230400 (Default=9600) <i>Parity</i> =N/E/O (Default=N) <i>Stopbit</i> =1/2 (Default=1) <i>Hwfc</i> = use dipswitch.
Description	The Serial parameters can be set or changed. The factory default is 9600, N, 1. To take effect of this command, ATZ or power off and on.
Reference	AT, ATZ, AT&F, ATS
Example	AT+UARTCONFIG,9600,N,1

### 5 AT+USEDIP?

SD Response	↵m↵
Purpose	Check the Baud rate set by dip switch
Description	m=0: Set to 'AT cmd' m=1: Set to other than 'AT cmd'
Reference	AT, ATZ, AT&F, ATS

## 6 AT+BTINFO? ↵

SD Response	↵12233445566,DeviceName,Mode,Status,Auth,Encryp,FlowControl↵ ↵OK↵
Purpose	Display Bluetooth settings
Description	The current Bluetooth settings are displayed including BD address, Device name, Operation mode, Operation status, Authentication, Data Encryption, and Hardware Flow Control. The initial value of Device name is 'PSD100v1.0.0-445566'. PSD stands for Promi-SD, v1.0.0 for the version of firmware, and 445566 for the last 6 digits of BD address. Mode=MODE0/MODE1/MODE2/MODE3 Status=STANDBY/PENDING/CONNECT Auth=0/1 (Authentication is not activated when 0) Encrypt=0/1 (Encryption is not activated when 0) FlowControl= <b>HWFC</b> /NoFC
Reference	AT+BTNAME, AT+BTMODE, AT+BTSEC, ATS14?
Example	↵000B530011FF,SENA,MODE0,PENDING,1,1, <b>HWFC</b> ↵

## 7 AT+BTINQ? ↵

SD Response	↵12233445566,FriendlyName,CoD↵ ↵12233445566,FriendlyName,CoD↵ ↵12233445566,FriendlyName,CoD↵ ↵OK↵
Purpose	Search Bluetooth devices nearby
Description	The Bluetooth devices in Inquiry scan mode nearby are displayed with their BD addresses, Device names, and Class of device. Maximum 10 devices are scanned for 30 seconds.
Reference	AT+BTSCAN, ATD, AT+BTINFO?

## 8 AT+BTLAST? ↵

SD Response	↵12233445566↵ ↵OK↵
Purpose	Display the BD address of the last connected device
Description	The Bluetooth device connected to this Promi-SD last time is displayed with its BD address.
Reference	AT+BTSCAN, ATD, AT+BTINFO?, AT+BTINQ?

## 9 AT+BTVER? ↵

SD Response	↵SD100v1.0.0↵
-------------	---------------

	⚡OK⚡
Purpose	Display device firmware version
Description	Display device firmware version
Reference	AT+BTINFO?

## 10 AT+BTRSSI,n ↵

SD Response	⚡OK⚡ ⚡0,255,0,0⚡ (repeat)
Purpose	Set operation mode
Parameters	n=0: Start sensitivity test n=1: Stop sensitivity test
Description	When Bluetooth connection is established, you can use this command in Standby status. The sensitivity will be displayed repeatedly in order of Status, LinkQuality, Status, RSSI. If the LinkQuality is close to 255 and RSSI is close to 0, the sensitivity is not bad.
Example	+++ AT+BTRSSI,1 ⚡OK⚡ 0,255,0,0

## 11 AT+BTMODE,n ↵

SD Response	⚡OK⚡
Purpose	Set operation mode
Parameters	n=0: MODE0 (Default) n=1: MODE1 n=2: MODE2 n=3: MODE3
Description	When the operation status is 'Pending' currently, change the status to 'Standby' with AT+BTCANCEL prior to this command. To take effect of this command, ATZ or power off and on.
Reference	AT+BTINFO?
Example	AT+BTMODE,2 ⚡OK⚡ ATZ

## 12 +++

SD Response	⚡OK⚡
Purpose	Convert the operation status of 'Connect' to 'Standby'
Description	In 'Connect' status, data from host is transmitted to the other side Bluetooth device, and any AT command is not accepted but this command, which is not echoed on the screen. When Promi-SD encounters a character '+' from host, it stops the data transmission and waits for next 2 characters. If the next 2 characters aren't both '+', it restart to transmit data including the first '+' as well. If not, it converts the operation status to 'Standby'. If the data from host includes '+++', it will convert the operation status to 'Standby' unexpectedly. Notice that Promi-SD holds data transmission when it encounters '+', until receiving next character.

	'+' is an escape sequence character by default, which is changeable by AT+SETESC.
Reference	AT+SETESC, ATO, AT+BTCANCEL

### 13 AT+SETESC,*nn*

SD Response	↵OK↵
Purpose	Change the escape sequence character
Parameters	<i>nn</i> =Decimal number of ASCII code (Default=43)
Description	Escape sequence character set to '+' by default is changeable. The parameter <i>nn</i> must be a printable character.
Reference	+++ , ATO
Example	AT+SETESC,42

### 14 ATO

SD Response	None
Purpose	Convert the operation status of 'Standby' to 'Connect'
Description	You can convert the operation status of 'Standby' to 'Connect' ready to transmit data.
Reference	+++ , AT+SETESC

### 15 AT+BTCANCEL

SD Response	↵OK↵
Purpose	Terminate a current executing task
Description	This terminates a current executing task, such as Inquiry scan and Page scan, then converts the operation status to 'Standby'.
Reference	AT+BTSCAN, ATD, AT+BTINQ?

### 16 AT+BTSCAN

SD Response	↵OK↵ ↵CONNECT 112233445566↵
Purpose	Wait for inquiry and connection from other Bluetooth devices
Description	This allows the inquiry and connection from the other Bluetooth devices. The operation status will be in 'Pending' after this command. When connection is made and released, the operation status is back to 'Pending'. To convert the operation status to 'Standby' AT+BTCANCEL must be used. This has the same effect as AT+BTSCAN,3,0. When connection is made with other Bluetooth device, SD response will be 'CONNECT' with its BD address.
Reference	ATD, AT+BTINQ?, AT+BTCANCEL

### 17 AT+BTSCAN,*n,to*

SD Response	↵OK↵ ↵CONNECT 112233445566↵
-------------	--------------------------------

	or <del>OK</del> <del>ERROR</del>
Purpose	Wait for inquiry and connection from other Bluetooth devices for a given duration
Parameters	n=1: Allows Inquiry scan n=2: Allows Page scan n=3: Allows both of Inquiry scan and Page scan to= Time duration in seconds
Description	For the given to, Promi-SD is waiting for the inquiry and connection from other Bluetooth devices. If the parameter of to is 0, it will wait forever. When connection is made with other Bluetooth device, SD response will be 'CONNECT' with its BD address. If there is no connection made within this time duration, SD response is 'ERROR' and the operation status becomes to 'Standby'.
Reference	ATD, AT+BTINQ?, AT+BTCANCEL
Example	AT+BTSCAN,2,30

## 18 AT+BTSCAN112233445566,to↵

SD Response	<del>OK</del> <del>CONNECT 112233445566</del> or <del>OK</del> <del>ERROR</del>
Purpose	Wait for connection by the Bluetooth device with given BD address
Parameters	112233445566=BD address to= time duration in seconds
Description	For the given to, Promi-SD is waiting for the connection from the Bluetooth device with the given BD address. If the parameter of to is 0, it will wait forever. When connection is made with the Bluetooth device, SD response will be 'CONNECT' with its BD address. If there is no connection made within this time duration, SD response is 'ERROR' and the operation status becomes to 'Standby'.
Reference	ATD, AT+BTINQ?, AT+BTCANCEL
Example	AT+BTSCAN000B530011FF,30

## 19 ATD↵

SD Response	<del>OK</del> <del>CONNECT 112233445566</del> or <del>OK</del> <del>ERROR</del>
Purpose	Connect to the last connected Bluetooth device
Description	Promi-SD saves the BD address of the Bluetooth device most recently connected. ATD can make connection to it without input its BD address. If it fails to make connection, SD response is 'ERROR'.
Reference	AT+BTINQ?, AT+BTSCAN

## 20 ATD112233445566↵

SD Response	↵OK↵ ↵CONNECT 112233445566↵ or ↵OK↵ ↵ERROR↵
Purpose	Connect to the Bluetooth device with given BD address
Parameters	112233445566=BD address
Description	Promi-SD attempts to connect to the Bluetooth device with the given BD address. To make successful connection, the Bluetooth device must be in Page scan. This attempt continues for 5 minutes. If it fails to make connection, SD response is 'ERROR'.
Reference	AT+BTINQ?, AT+BTSCAN
Example	ATD000B530011FF

## 21 ATH↵

SD Response	↵OK↵ ↵DISCONNECT↵
Purpose	Release the current connection
Description	The current Bluetooth connection is released normally. It takes about 30 seconds to detect an abnormal disconnection such as power off and moving out of service range.
Reference	ATD, AT+BTSCAN

## 22 AT+BTKEY=\$string↵

SD Response	↵OK↵
Purpose	Change pin code
Parameters	\$string= New pin code (Default= " 1234" )
Description	Pin code is a string, which allows 16 alpha-numeric characters maximum. Based on this pin code, Promi-SD generates a link key which is used in actual authentication process.
Reference	AT+BTCSD, AT+BTFF, AT+BTSD?, AT+BTSEC, ATZ, AT&F
Example	AT+BTKEY= " apple"

## 23 AT+BTSD? ↵

SD Response	↵112233445566↵ ↵OK↵
Purpose	Display the list of Bluetooth devices sharing the pin code
Description	Once a connection is made with pin code, Promi-SD saves the Bluetooth device with its link key generated by pin code. The connection to a device listed in Promi-SD can be made automatically without authentication process. The maximum number of the list is 5.
Reference	AT+BTCSD, AT+BTFF, AT+BTKEY, AT+BTSEC, ATZ, AT&F

## 24 AT+BTCSD↵

SD Response	↵OK↵
-------------	------



Purpose	Clear the list of Bluetooth devices sharing the pin code
Description	This clears the list of Bluetooth devices with link key in flash memory. To take effect of this command, ATZ or power off and on because the main memory still has the list.
Reference	AT+BTFF, AT+BTKEY, AT+BTSD?, AT+BTSEC, ATZ, AT&F

## 25 AT+BTFF,*n*

SD Response	↵OK↵
Purpose	Set generation of link key every time of connection
Parameters	<i>n</i> =0: Inactivate (Default) <i>n</i> =1: Activate
Description	If <i>n</i> is set to 1, Promi-SD asks pin code every time of connection. This is used to level up the security.
Reference	AT+BTCSD, AT+BTKEY, AT+BTSD?, AT+BTSEC, ATD, ATZ, AT&F

## 26 AT+BTSEC,Authentication,Encryption

SD Response	↵OK↵
Purpose	Set authentication and data encryption
Parameters	<i>Authentication</i> =0: Inactivate (Default) <i>Authentication</i> =1: Activate <i>Encryption</i> =0: Inactivate (Default) <i>Encryption</i> =1: Activate
Description	If the authentication is activated, the pin code must be set by AT+BTKEY command. Data encryption cannot be used when authentication is not activated, i.e. <i>Authentication</i> =0 and <i>Encryption</i> =1 is not valid.
Reference	AT+BTCSD, AT+BTFF, AT+BTSD?, AT+BTSEC, ATZ, AT&F

## 27 AT+BTNAME=*\$string*

SD Response	↵OK↵
Purpose	Change device name
Parameters	<i>\$string</i> = New device name (Default= " PSDv3b-445566" )
Description	Promi-SD can have a user friendly name to identify easily. The name allows 30 alphanumeric characters maximum.
Reference	AT+BTINFO?, AT+BTINQ?
Example	AT+BTNAME=" My-Promi-SD"

## 28 AT+BTLPM,*n*

SD Response	↵OK↵
Purpose	Set low power mode
Parameters	<i>n</i> =0: Inactivate (Default) <i>n</i> =1: Activate
Description	During no data transmission, Promi-SD can be in low power mode to save the power consumption. It takes a few seconds to wake up Promi-SD in low power mode.

**29 AT+DFU↵**

SD Response	(Display garbage messages repeatedly)
Purpose	Device firmware update
Description	DO NOT use this command in console. Because the SD enter into firmware update mode, garbage messages will appear. This command is used by PromiWin's firmware update menu.

**30 AT&V↵**

SD Response	↵\$0:m0;\$1:m1; ...\$n:mn↵ ↵OK↵
Purpose	Display all the S-register
Description	All parameters are stored at S-register in flash memory. These values are sustained until hardware reset.
Reference	ATS

**31 ATSnn?↵**

SD Response	↵value↵ ↵OK↵
Purpose	Display a given S-register
Parameters	nn= Address of S-register
Description	A specific S-register is displayed.
Reference	AT&V

**32 ATSnn=mm↵**

SD Response	↵OK↵
Purpose	Change S-register value
Parameters	nn= Address of S-register mm= New value of S-register
Description	Some S-registers are optimized for the overall performance and protected from an arbitrary change by user. When users try to change these S-registers, SD response is 'ERROR'. For details of S-register, refer Appendix. B.
Reference	AT&V
Example	ATS10=0

## Command Validity

AT Command	Operation Status		
	Standby	Pending	Connect
AT	<input type="radio"/>	<input type="radio"/>	
ATZ	<input type="radio"/>	<input type="radio"/>	
AT&F	<input type="radio"/>	<input type="radio"/>	
AT+BTINQ?	<input checked="" type="radio"/>		
ATD112233445566	<input checked="" type="radio"/>		
ATD	<input checked="" type="radio"/>		
AT+BTSCAN	<input checked="" type="radio"/>		
AT+BTSCAN,n,to	<input checked="" type="radio"/>		
AT+BTSCAN112233445566,to	<input checked="" type="radio"/>		
AT+BTCANCEL		<input type="radio"/>	
+++			<input type="radio"/>
AT+SETESC	<input checked="" type="radio"/>		
ATO	<input checked="" type="radio"/>		
ATH	<input checked="" type="radio"/>		
AT+BTSEC,Auth,Encr	<input checked="" type="radio"/>		
AT+BTLAST?	<input type="radio"/>	<input type="radio"/>	
AT+BTMODE,n	<input checked="" type="radio"/>		
AT+BTNAME="Name"	<input checked="" type="radio"/>		
AT+BTKEY="nnnn"	<input checked="" type="radio"/>		
AT+BTINFO?	<input type="radio"/>	<input type="radio"/>	
AT+BTLPM,n	<input checked="" type="radio"/>		
AT+BTSD?	<input type="radio"/>	<input type="radio"/>	
AT+BTCSD	<input checked="" type="radio"/>		
AT+BTFF,n	<input checked="" type="radio"/>		
AT+UARTCONFIG,b,p,s (SD205)	<input checked="" type="radio"/>		
AT+USEDIP?	<input type="radio"/>	<input type="radio"/>	
AT+BTVER?	<input type="radio"/>	<input type="radio"/>	
AT+DFU	<input checked="" type="radio"/>	<input checked="" type="radio"/>	
AT+BTRSSI,n	<input checked="" type="radio"/>		

⊙ Valid only when Promi-SD is not connected to other Bluetooth device.

● Valid only when Promi-SD is connected to other Bluetooth device.

## Appendix B. S-Register

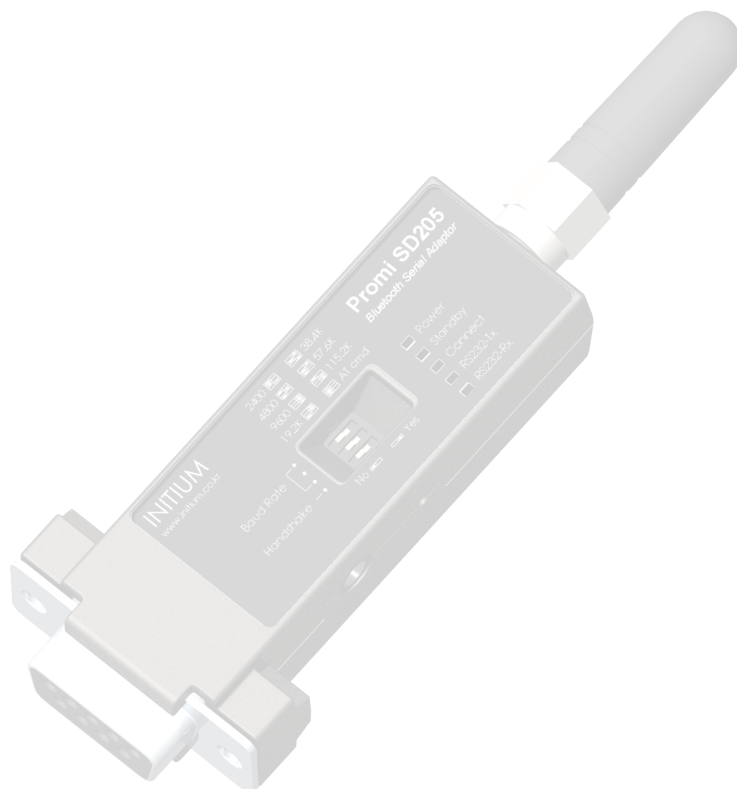

get **UNWIRED**, it's easy!

## S-Register

S-registers contain 46 parameters of Promi-SD. These are stored in flash memory and sustained the values unless hardware reset is executed. The value of S-register can be accessed and changed with ATS command by user. Some S-registers not shown below are set to maximize the performance of Promi-SD. Thus it is not recommended to change these S-registers.

Change the value of S-register only in Standby status.

### ↘ **S1: Force to Reconnect (default 1)**

S1=0, Promi-SD in Mode1 does not try reconnection when disconnected.

S1=1, Promi-SD in Mode1 keeps trying reconnection when disconnected.

### ↘ **S2: UART\_FLOWCONTROL (default 0)**

S2=0, Promi-SD's hardware flow control is off.

### ↘ **S3: Stream UART Policy (default 0)**

S3=0, the priority of UART streaming is throughput.

S3=1, the priority is latency, which minimizes the delay of data transmission. This is useful in case of transmitting very small data quickly.

This value decides the way of handling stream data from UART. When this value is 1, in order that SD minimizes the latency, SD sends the received data immediately. When this value is 0, in order that SD maximizes throughput, SD stores received data for a short time and sends a large packet. If the packet length is less than 100 bytes, latency-oriented way is better. But if the packet length is more than 100 bytes, throughput-oriented way is recommended. Also if you want to use high baudrate, throughput-oriented way is more effective. Just for reference, the buffer length for receiving is 2 Kbytes.

### ↘ **S4: Enable Remote Name Query (default 1)**

S4=0, Promi-SD inquires only BD address. This speeds up the inquiry process.

S4=1, Promi-SD inquires BD address, device name and class of device.

This value decides whether SD finds friendly name of Bluetooth device or not. When this value is 1, SD finds not only BD address but also friendly name. When this value is 0, SD finds only BD address. Without finding friendly name, a searching is quick to respond. If you want to search the other Bluetooth devices quickly, set this value to 0. In case of using pairing button, finding friendly name will be omitted automatically.

### ↘ **S6: Enable Low Power Mode (default 0)**

S10=0, deactivate Low Power Mode.

S10=1, activate Low Power Mode.

This value decides whether SD works in Low Power Mode or not. When this value is 0, SD works only in active power mode. When SD works in Low Power mode, delay in transferring data may occur.

### ↘ **S10: Enable SD Response (default 1)**

S10=0, Promi-SD does not send SD responses to host system.

S10=1, Promi-SD send SD responses to host system.

This value decides whether SD sends response messages such as OK, ERROR, CONNECT, DISCONNECT or not. When this value is 0, SD sends no response messages. If the response messages cause troubles in host programs or devices that is connected to SD, change this value to 0.

### ↘ **S11: Enable Escape (default 1)**

S11=0, Promi-SD does not allow escape sequence character. The operation status of Connect cannot be changed to Standby. As Promi-SD skips the process detecting escape sequence character, the more efficient data transmission is expected.

S11=1, Promi-SD allow escape sequence character. Whenever it is needed, the Connect status can be changed to Standby.

#### ☛ **S12: Clear Data Buffer When Disconnected (default 0)**

S12=0, Promi-SD does not clear the data buffer received from host system when disconnected.

S12=1, Promi-SD clears the data buffer when disconnected.

#### ☛ **S14: Enable DTR Transfer (default 1)**

S14=0, DTR/DSR signal is transferred to loop-back.

S14=1, DTR signal is transferred to DSR of remote device.

#### ☛ **S15: Enable Disconnect by DTR (default 0)**

S15=0, DTR signal cannot release the connection.

S15=1, The Bluetooth connection can be released when DTR signal is off.

This value decides whether Bluetooth connection is released when DTR signal drops or not. If this value is 1, you can use DTR signal in order to disconnect Bluetooth connection.

#### ☛ **S22: Fast Connect (default 0)**

S22=0, none

S22=1, page scan

S22=2, inquiry scan

S22=3, page/inquiry scan

#### ☛ **S24: Maximum Number of Inquiry Result (default 10)**

The maximum number of inquiry list can be controlled. This value is up to 15,

#### ☛ **S28: Escape Sequence Character (default 43)**

The decimal number of the ASCII code of escape sequence character can be controlled. The initial value is 43, the ASCII code of '+'.  
 The decimal number of the ASCII code of escape sequence character can be controlled. The initial value is 43, the ASCII code of '+'.

#### ☛ **S31: Page Timeout (default 300)**

This is the timeout in seconds to attempt connection with ATD command. After this timeout expires, the SD will restart automatically. If this value is 0, SD will attempt to connect without restarting

#### ☛ **S33: Inquiry Timeout (default 30)**

This is the timeout in seconds to execute inquiry scan.

#### ☛ **S37: Supervision Timeout (default 16000)**

This is the timeout in 625 $\mu$ sec to presume disconnection, which is set to 16000 initially. 16000  $\times$  625 $\mu$ sec=10sec)

The smaller the value becomes, the more quickly Promi-SD can detect an abnormal disconnection. But when the communication is suspended for some environmental reasons, it may be regarded as disconnection.

#### ☛ **S46: BD Address of Last Connected Device**

This saves the BD address of the Bluetooth device connected most recently.

# Appendix C. Technical Support

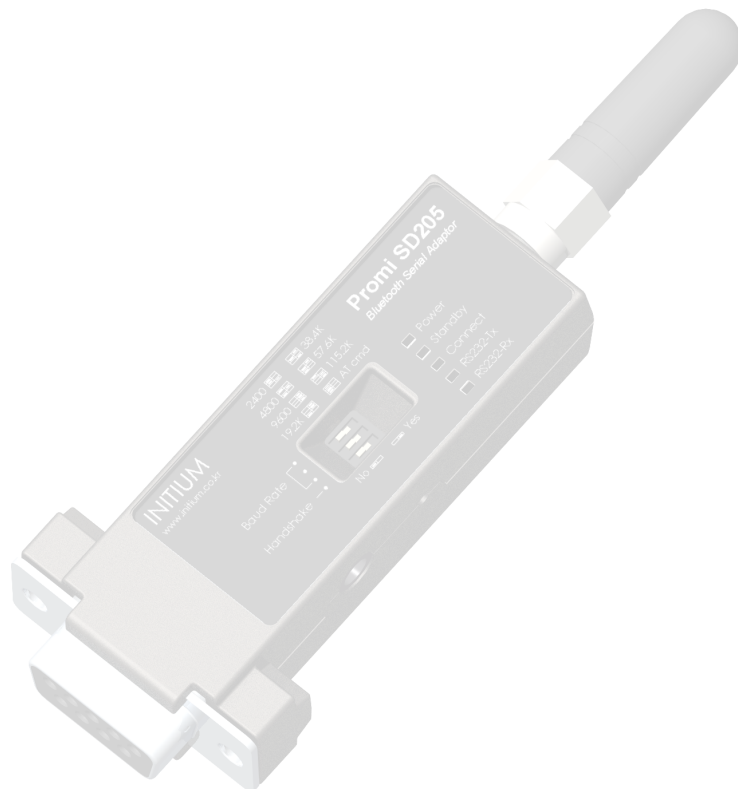

get **UNWIRED**, it's easy!



Use this form to request technical support for Promi-SD. Individual form should be filled out for each Promi-SD in question. Referring to the example on separate sheet, please provide as much information as possible so we may resolve and respond to your inquiry promptly. When you have finished, submit this form by e-mail to [support@sena.com](mailto:support@sena.com) or by fax to +82 2 573-7710.

NOTE: Before you contact technical support, please have a look at our FAQ. Chances are, you will find an instant answer to your problem.

✓ indicates a required field.

▾ **User Contact Information**

Name ✓	
Company	
E-mail ✓	
Phone ✓	
Fax ✓	

▾ **Overall Hardware Setup** ✓

(Depict or describe actual hardware connections)
--

▾ **Host Device (to which Promi-SD is attached)**

Description ✓				
Serial Port Setup	Port		Parity ✓	
	Baud Rate ✓		Stop Bits ✓	
	Data Bits ✓		Flow Control ✓	
Comments				

▾ **Promi-SD**

Model Name ✓		BD Address* ✓	
S-Register** ✓			

\* BD Address is the 6-digit number labeled on the product.

\*\* As for S-Register, the values are shown by "AT&V" command on a PC running Serial Port program (e.g. HyperTerminal). See the User's Manual for details.

➤ **Pin Assignment to Promi-SD**

Promi-SD205-OA				Host Device		
Direction	Signal	Pin #		Pin #	Signal	Direction
–	N/A	1	↔			
In	RxD	2	↔			
Out	TxD	3	↔			
–	N/A	4	↔			
–	N/A	5	↔			
In	Vcc	6	↔			
–	N/A	7	↔			
–	N/A	8	↔			
–	GND	9	↔			

➤ **Bluetooth Connection: This Promi-SD is connected to (mark one)**

<input type="checkbox"/> an another Promi-SD		
<input type="checkbox"/> a Promi-ESD		
<input type="checkbox"/> a Promi-MSP		
<input type="checkbox"/> others	Model ✓	
	Manufacture	
	Application S/W	

➤ **Environment for RF Communication**

Distance* ✓	
Obstacles** ✓	

➤ **Problems you have**

\* Distance is a linear distance between Promi-SD and the other side Bluetooth device.

\*\* Obstacles are things affecting RF performance in the middle of Promi-SD and the other side Bluetooth device, such as walls, partitions, other equipments, etc.

## Appendix D. Connection to Omron PLC

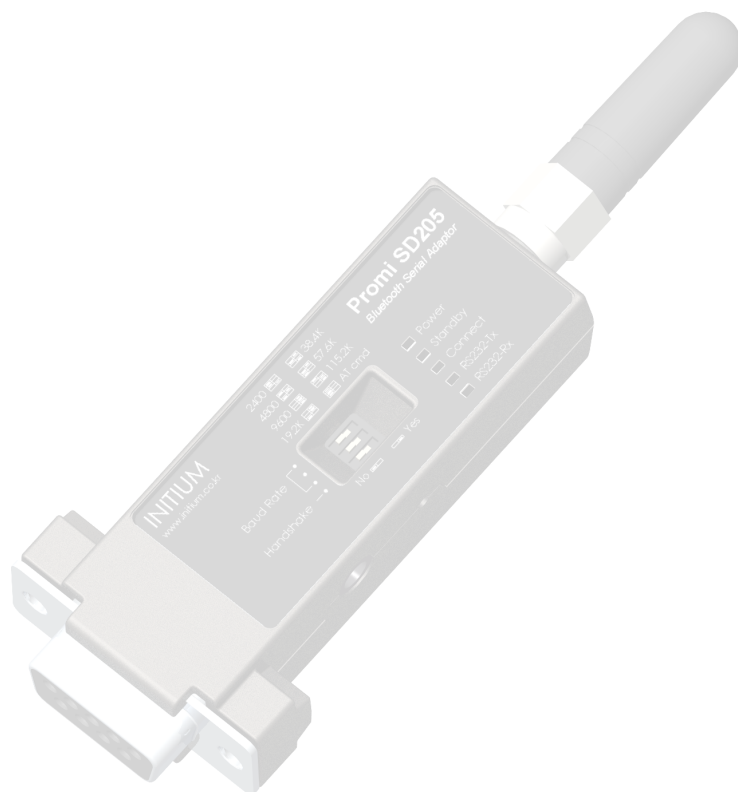

get **UNWIRED**, it's easy!

## Configure the Promi-SD205 OA for PC to PLC connection by Bluetooth?

Connect the Promi-SD205 OA to a COM port with the serial cable (PROMI-SD205-OA cable) and power it with 5V

Start PromiWin

Data bits are fixed to 8

Select the correct COM port from the drop down list

Select the correct baud rate (factory default is 9600)

Select the correct parity (factory default is None)

Select the correct stop bits (factory default is 1)

Press the OK button

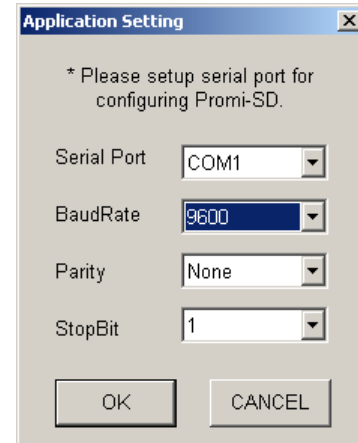

Select the **Device setting icon**.

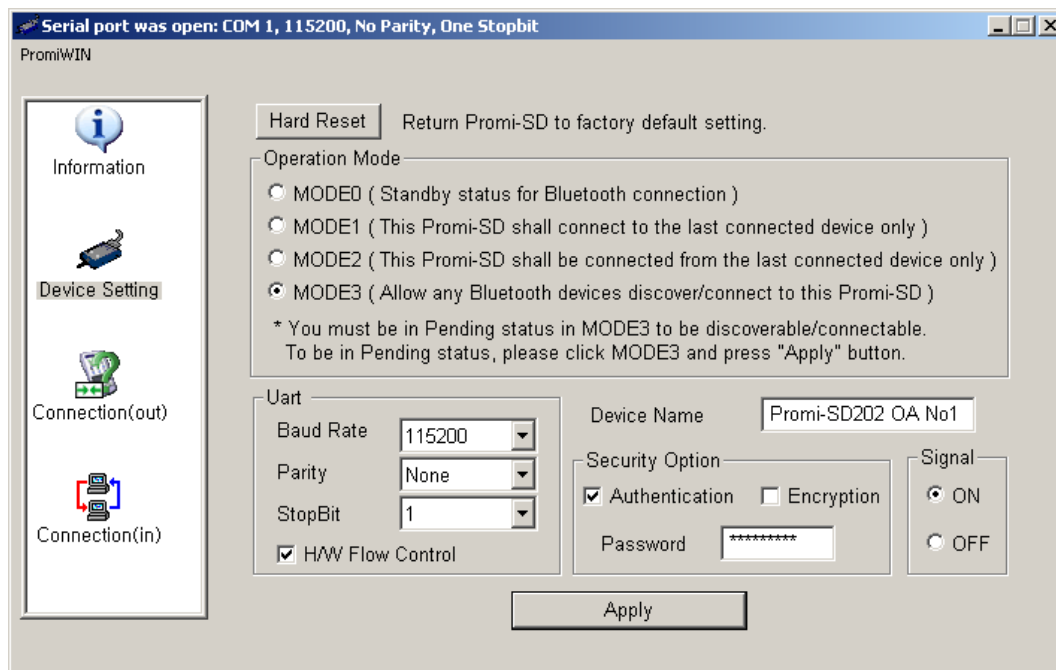

Select MODE3 by selecting the radio button

Set the Baud Rate, Parity and StopBit

(H/W Flow Control is not applicable for the Promi-SD205 OA)

Set a Device Name (16 characters max)

Tick the Authentication tickbox and set a Password (caption sensible)

*Note: Password is only saved if the tickbox Authentication is ticked*

Tick the Encryption tickbox (if preferred)

Click the Apply button to store all the settings in the Promi-SD205 OA

Close PromiWin

Power off the Promi-SD205 OA and power it on again

Select My Bluetooth places in Windows Explorer or in the taskbar

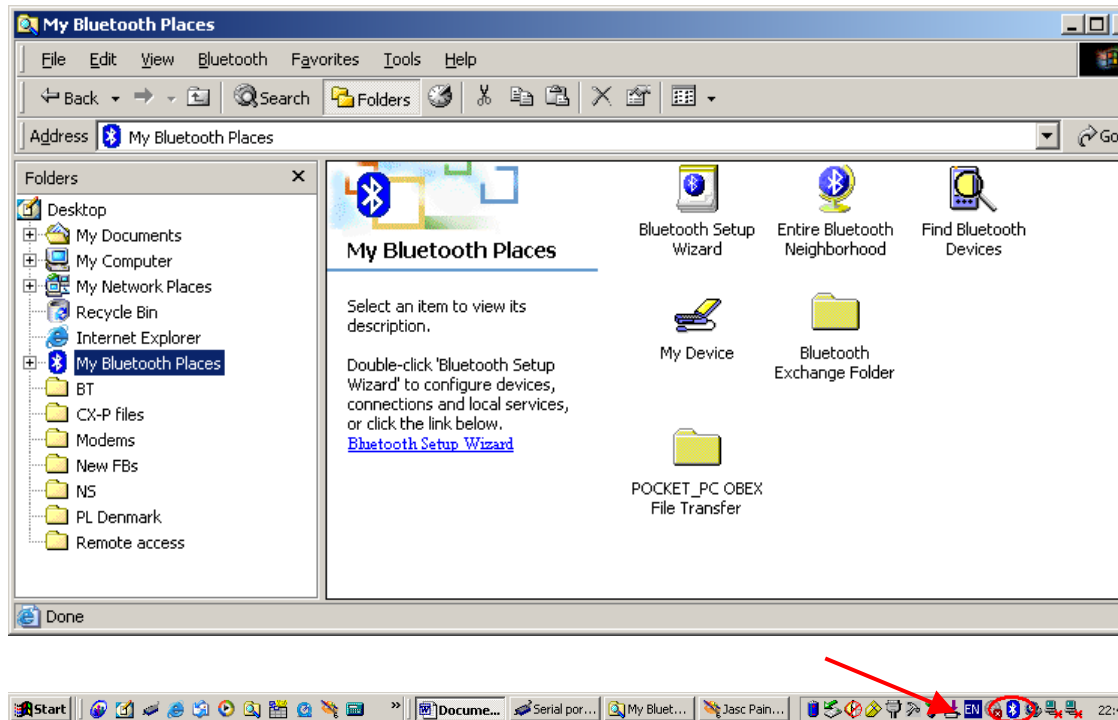

Double click on the **Find Bluetooth Devices** icon

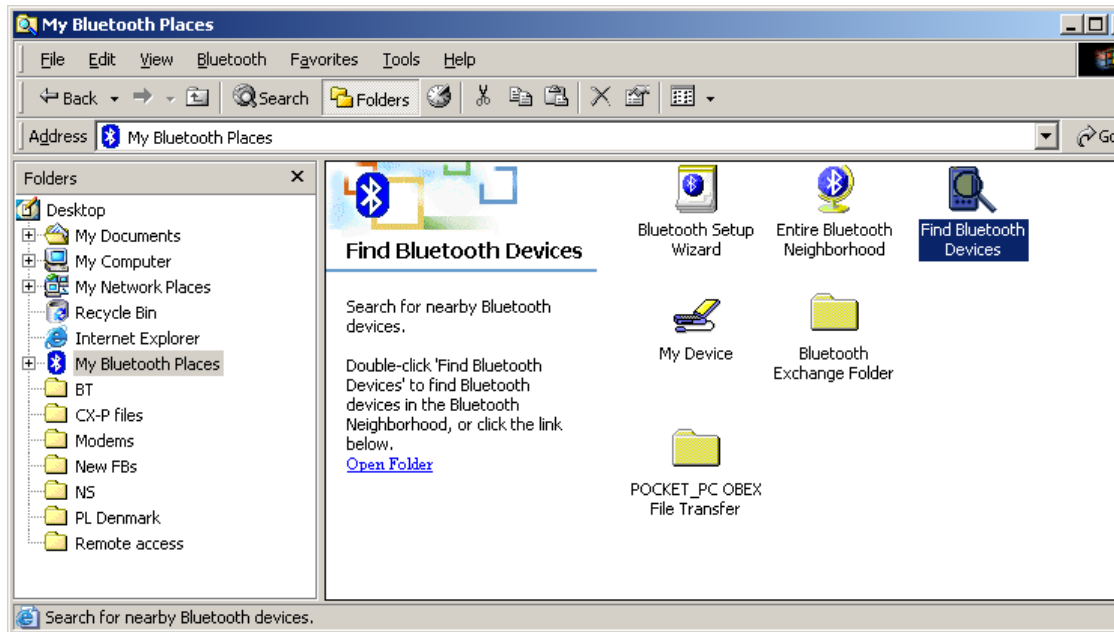

Double click on the device you want to connect to

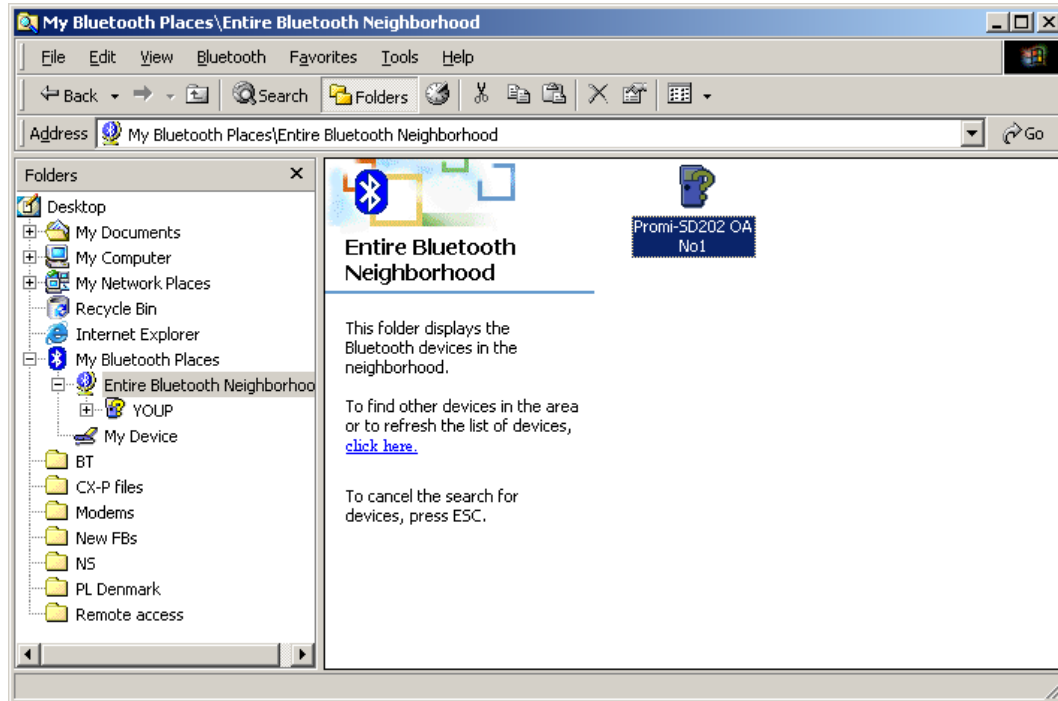

Double click on the **Generic Serial on .....** icon

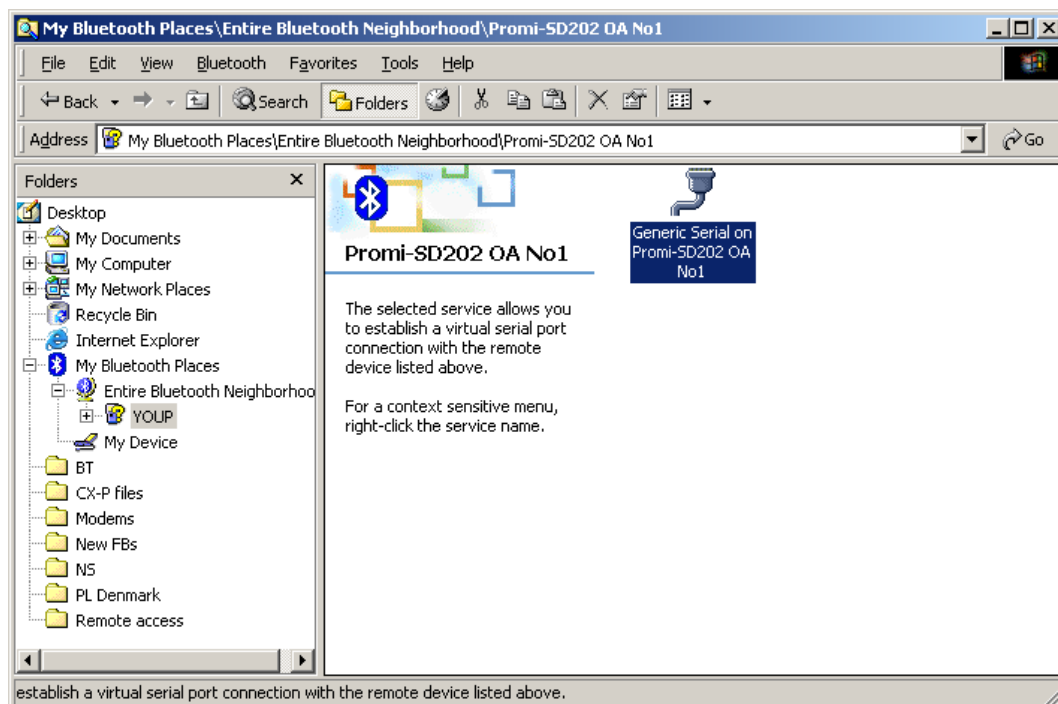

Select the call out box that appears

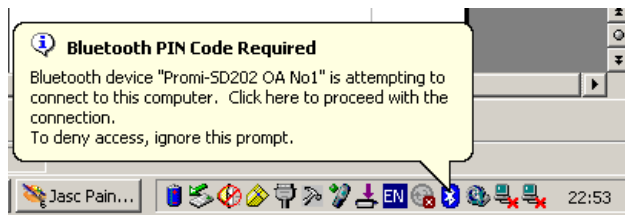

Enter the Password (caption sensible)

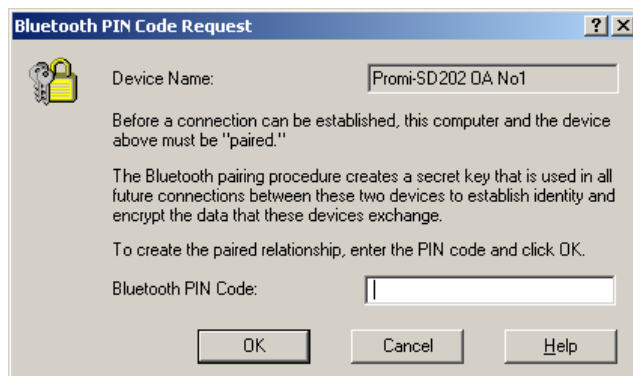

Connection is established

A message is shown what virtual COM port is used for the Bluetooth connection or double click on the generic serial icon and select the properties tab.

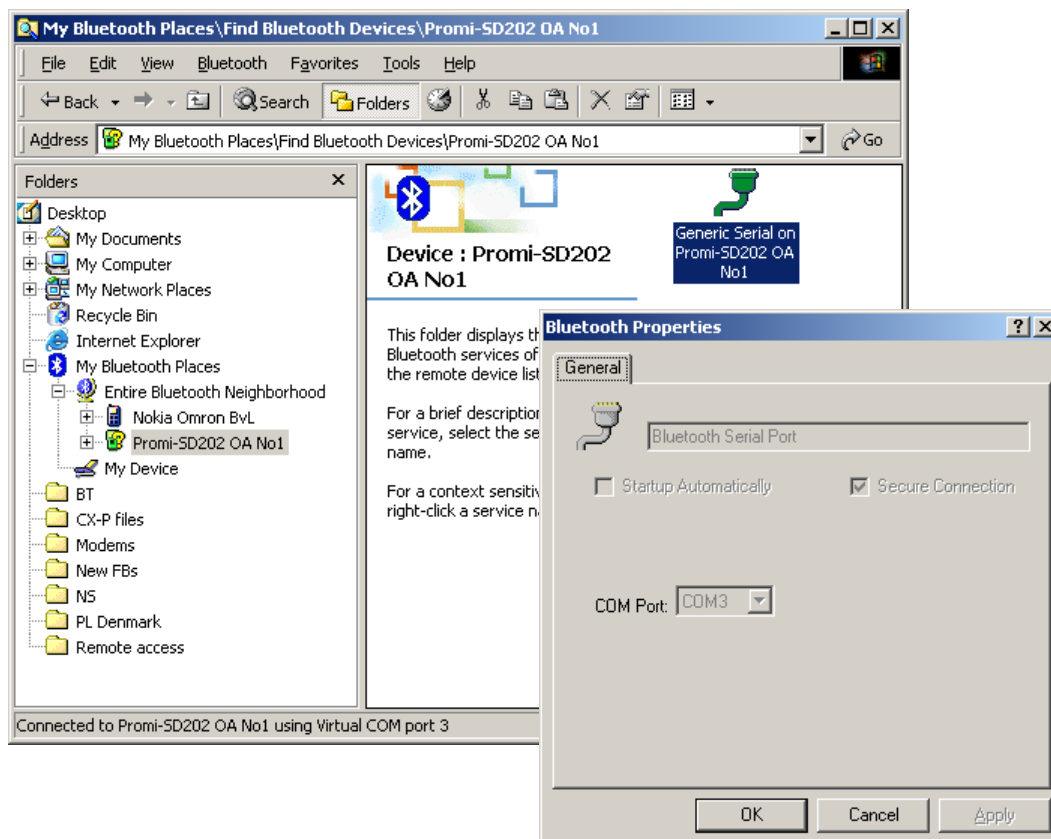



## Configure the PLC for PC to PLC connection by Bluetooth?

Start CX-Programmer and set the PLC settings the same as settings of the Promi-SD205-OA via the PLC settings in CX-P.

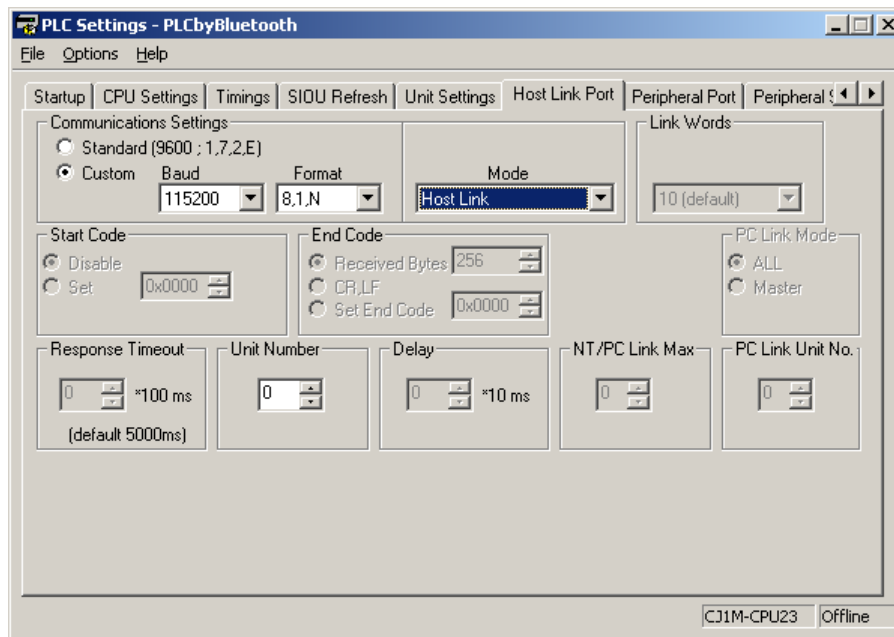

Transfer the settings to the PLC

Disconnect from the PLC

Change the settings of the PLC to the settings of the Bluetooth device

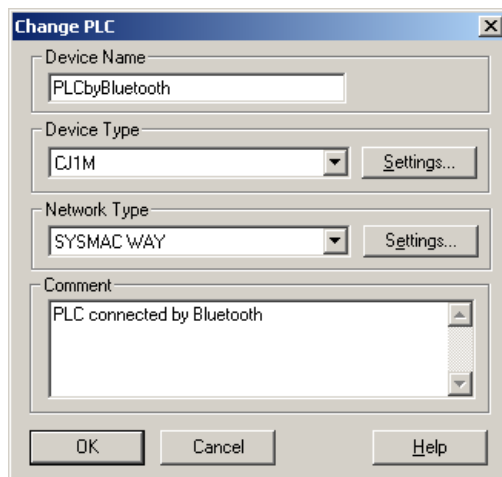

Select the virtual com port for Bluetooth and the correct data format

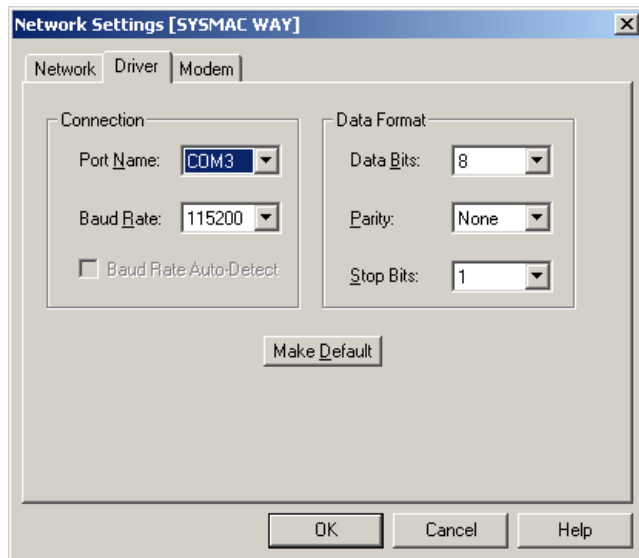

Go online with the PLC, you succeed in establishing connection to an Omron PLC with Bluetooth!!!!