



austriamicrosystems AG

is now

ams AG

The technical content of this austriamicrosystems datasheet is still valid.

Contact information:

Headquarters:

ams AG
Tobelbaderstrasse 30
8141 Unterpremstaetten, Austria
Tel: +43 (0) 3136 500 0
e-Mail: ams_sales@ams.com

Please visit our website at www.ams.com

AS1376

1A, Low Input Voltage, Low Quiescent Current LDO

1 General Description

The AS1376 is a Dual Supply Rail Linear Regulator designed to deliver 1A of load current while consuming only 67µA (typ) of ground current. In the typical post regulation application VBIAS is directly connected to the main input supply, (range 2.5V...5.5V) and VIN is supplied by the output voltage of a host DC-DC Converter (range 0.7V...4.5V).

The device offers excellent dropout (120mV @ 1A) and transient performance.

In shutdown (Enable pin pulled low), the device turns off and reduces quiescent current consumption to 10nA (typ) at both VBIAS and VIN terminals.

In shutdown, a 100Ω (typ) discharge path is connected between output and ground to provide rapid discharge of the overall load capacitance connected to the AS1376 output terminal. Auto-discharge minimizes the possibility that VOUT > VIN during shutdown. When VOUT > VIN, reverse current flows through the inherent body diode of the N-channel series pass transistor.

The AS1376 also features internal protection against over-temperature, over-current and under-voltage conditions.

The device is available in an 8-pin 2x2 TDFN package and is qualified for operation over the -40°C to +85°C temperature range.

The device is available in fixed output voltages from 0.5V up to 2.2V in 100mV steps (50mV from 0.5V to 1.1V). See [Ordering Information](#) on page 18.

2 Key Features

- Ultra-Low Dropout Voltage: <120mV @ 1A load
- Output voltages: 0.5V to 2.2V
- Input voltage: 0.7V to 3.6V
- Bias Supply Voltage: 2.5V to 5.5V
- Maximum Output Current: 1A
- Output Voltage Accuracy: ±2%
- Low Shutdown Current: 20nA
- Wide band VBIAS PSRR 45dB (typ) 10mA load
- Integrated Overtemperature / Overcurrent Protection
- Chip Enable Input
- Minimal external components required
- Operating Temperature Range: -40°C to +85°C
- 8-pin 2x2mm TDFN Package
- 2 weeks availability for non-standard devices between 0.5V and 1.1V in 50mV steps and between 1.1V and 2.2V in 100mV steps.

3 Applications

The devices are ideal for powering cordless and mobile phones, MP3 players, CD and DVD players, PDAs, hand-held computers, digital cameras and any other hand-held and/or battery-powered device.

Figure 1. AS1376 - Typical Application Diagram

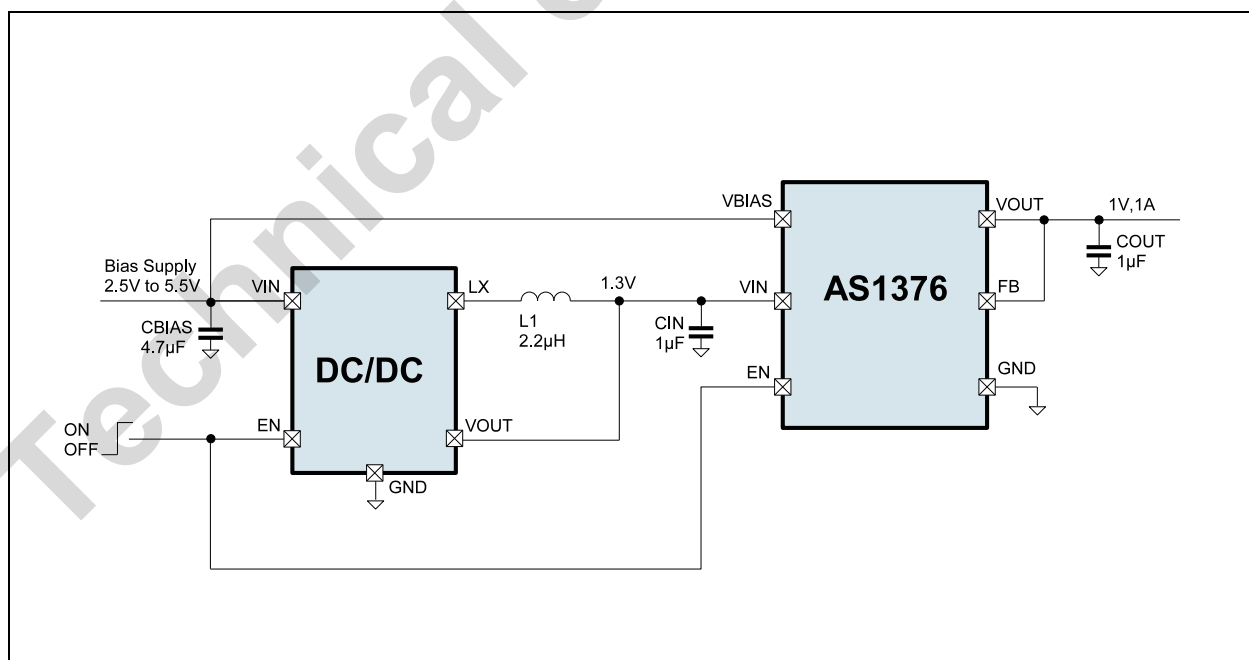

4 Pin Assignments

Figure 2. Pin Assignments (Top View)

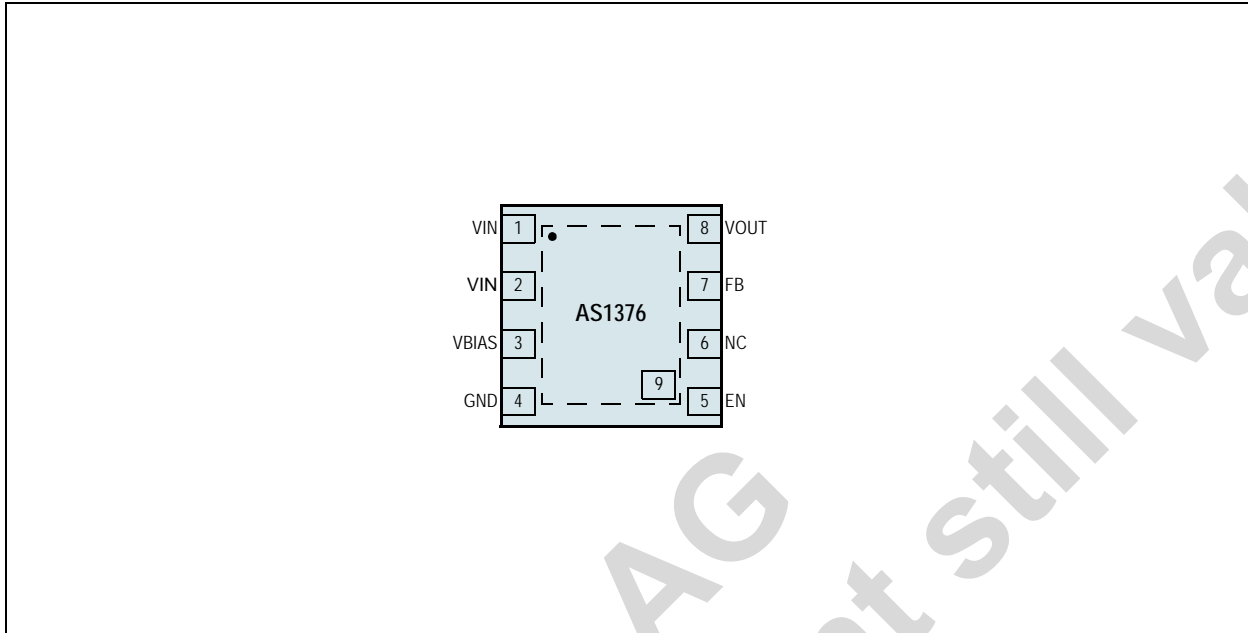

4.1 Pin Descriptions

Table 1. Pin Descriptions

Pin Number	Pin Name	Description
1, 2	VIN	Unregulated Input Voltage. 0.7V to 3.6V. Bypass this pin with a capacitor to GND.
3	VBIAS	Bias Input Voltage. 2.5V to 5.5V. Bypass this pin with a capacitor to GND.
4	GND	Ground.
5	EN	Enable. Pull this pin to low to disable the device.
6	NC	Leave this pin unconnected.
7	FB	Feedback Pin. Connect to VOUT to select the factory-preset output voltage. For the adjustable version connect to an external resistor divider to set output voltage.
8	VOUT	Regulated Output Voltage. 0.5V to 3.3V. Bypass this pin with a capacitor to GND.
9		Exposed Pad. This pad is not connected internally. Ensure a good connection to the PCB to achieve optimal thermal performance.

5 Absolute Maximum Ratings

Stresses beyond those listed in [Table 2](#) may cause permanent damage to the device. These are stress ratings only and functional operation of the device at these or any other conditions beyond those indicated in [Section 6 Electrical Characteristics](#) on page 4 is not implied. Exposure to absolute maximum rating conditions for extended periods may affect device reliability.

Table 2. Absolute Maximum Ratings

Parameter	Min	Max	Units	Notes
Electrical Parameters				
VIN to GND	-0.3	5	V	
VBIAS, EN to GND	-0.3	+6.5	V	
VOUT to GND	-0.3	VIN + 0.3	V	
Output Short-Circuit Duration		Indefinite		
Input Current (latch-up immunity)	-100	100	mA	JEDEC 78
Electrostatic Discharge				
Electrostatic Discharge HBM	2		kV	Norm: MIL 883 E method 3015
Temperature Ranges and Storage Conditions				
Thermal Resistance θ_{JA}	97		°C/W	Junction-to-ambient thermal resistance is very dependent on application and board-layout. In situations where high maximum power dissipation exists, special attention must be paid to thermal dissipation during board design.
Junction Temperature		+125	°C	
Storage Temperature Range	-55	+150	°C	
Humidity non-condensing	5	85	%	
Package Body Temperature	+260		°C	The reflow peak soldering temperature (body temperature) specified is in accordance with <i>IPC/JEDEC J-STD-020 "Moisture/Reflow Sensitivity Classification for Non-Hermetic Solid State Surface Mount Devices"</i> . The lead finish for Pb-free leaded packages is matte tin (100% Sn).
Humidity non-condensing	5	85	%	

6 Electrical Characteristics

$V_{IN} = V_{OUT} + 0.2V$, $V_{BIAS} = V_{OUT} + 1.5V$ (or $2.5V$ whichever is larger), $EN = V_{BIAS}$, $C_{IN} = C_{OUT} = 1\mu F$, $C_{BIAS} = 4.7\mu F$, $T_{AMB} = -40^{\circ}C$ to $+85^{\circ}C$. Typical values are at $T_{AMB} = +25^{\circ}C$ (unless otherwise specified).

Table 3. Electrical Characteristics

Symbol	Parameter	Conditions	Min	Typ	Max	Units
T _{AMB}	Operating Temperature Range		-40		+85	°C
V _{IN}	Input Voltage		0.7		3.6	V
V _{BIAS}	Bias Supply Voltage		2.5		5.5	V
V _{OUT}	Output Voltage	Available in 100mV steps (see Ordering Information on page 18)	0.5		3.3	V
V _{OUT(NOM)} - V _{OUT}	Output Voltage Accuracy	I _{OUT} = 100μA	-1.5		+1.5	%
		I _{OUT} = 0A to 1A	-2		+2	
V _{FB}	Feedback Voltage ¹	I _{OUT} = 100μA	492	500	508	mV
		I _{OUT} = 0A to 1A	490	500	510	
$\Delta V_{OUT} / \Delta V_{IN}$	Line Regulation V _{IN}	I _{OUT} = 100μA		40		μV/V
$\Delta V_{OUT} / \Delta V_{BIAS}$	Line Regulation V _{BIAS}	I _{OUT} = 100μA		135		μV/V
ΔV_{LDR}	Load Regulation	I _{OUT} = 1mA to 1A		0.0002		%/mA
I _{OUT}	Output Current ²		1			A
I _{LIM}	Current Limit	V _{OUT} forced to 90% of nominal V _{OUT}		1.35		A
V _{DROP-VIN}	Output Voltage Dropout V _{IN}	V _{BIAS} = V _{OUT} + 1.5V, I _{OUT} = 1A		120		mV
		V _{BIAS} = V _{OUT} + 1.8V, I _{OUT} = 1A		115		
		V _{BIAS} = V _{OUT} + 2.1V, I _{OUT} = 1A		110		mV
		V _{BIAS} = 5.5V, I _{OUT} = 1A		105		
V _{DROP-VBIAS}	Output Voltage Dropout V _{BIAS}	I _{OUT} = 500mA		0.85		
		I _{OUT} = 1A		1.1		V
En	Output Voltage Noise	f = 10Hz to 100kHz, I _{OUT} = 1mA		65		μV _{RMS}
PSRR - V _{IN}	Power-Supply Rejection Ratio Sine modulated V _{IN}	f = 100Hz, I _{OUT} = 10mA		78		dB
		f = 1kHz, I _{OUT} = 10mA		61		
		f = 10kHz, I _{OUT} = 10mA		54		
		f = 100kHz, I _{OUT} = 10mA		60		
PSRR - V _{BIAS}	Power-Supply Rejection Ratio Sine modulated V _{BIAS}	f = 100Hz, I _{OUT} = 10mA		69		dB
		f = 1kHz, I _{OUT} = 10mA		51		
		f = 10kHz, I _{OUT} = 10mA		45		
		f = 100kHz, I _{OUT} = 10mA		45		
I _{Q_VBIAS}	Quiescent Current into V _{BIAS}			60	120	μA
I _{Q_VIN}	Quiescent Current into V _{IN}	I _{OUT} = 0mA		6.5	8	
I _{SHDN-VBIAS}	Shutdown Current into V _{BIAS}	V _{EN} = 0V		0.02		μA
I _{SHDN-VIN}	Shutdown Current into V _{IN}			0.02		

Table 3. Electrical Characteristics

Symbol	Parameter	Conditions	Min	Typ	Max	Units
Shutdown						
I _{EN}	Enable Input Bias Current			0.001	1	μA
V _{IH}	Enable Input Threshold	V _{IN} = 0.7 to 3.6V	1			V
V _{IL}					0.4	
Thermal Protection						
T _{SHDN}	Thermal Shutdown Temperature			155		°C
ΔT _{SHDN}	Thermal Shutdown Hysteresis			30		°C
Transient Characteristics						
ΔV _{OUT}	Dynamic Load Transient Response V _{BIAS}			±35		mV
t _{ON}	Exit Delay from Shutdown	Settling to 95%, no Load		72		μs
C _{OUT}	Output Capacitor	Load Capacitor Range	1		10	μF
		Maximum ESR Load			500	mΩ

1. Valid for adjustable output version only.
2. Limit guaranteed by design and characterization.

Note: All limits are guaranteed. The parameters with min and max values are guaranteed with production tests or SQC (Statistical Quality Control) methods.

7 Typical Operating Characteristics

$V_{IN} = 1.2V$, $V_{BIAS} = 2.5V$, $V_{OUT} = 1.0V$, $EN = V_{BIAS}$, $C_{IN} = C_{OUT} = 1\mu F$, $C_{BIAS} = 4\mu F$. Typical values are at $T_{AMB} = +25^{\circ}C$ (unless otherwise specified).

Figure 3. Bias Supply Current vs. Bias Supply Voltage

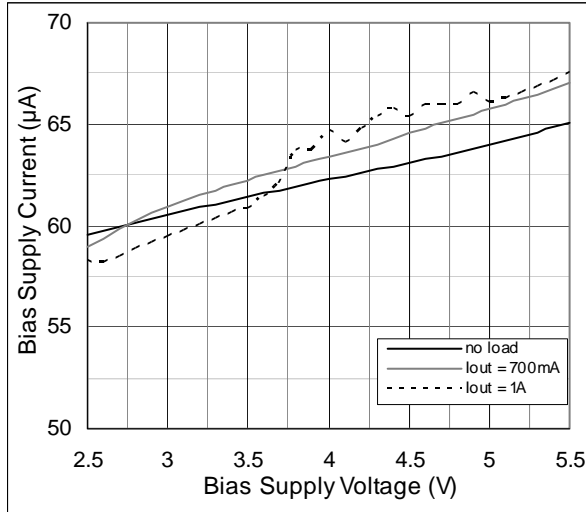

Figure 4. Bias Supply Current vs. Bias Supply Voltage

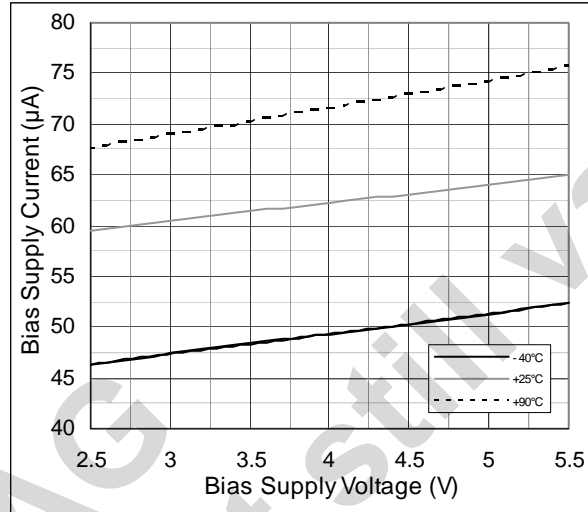

Figure 5. Ground Current vs. Bias Supply Voltage

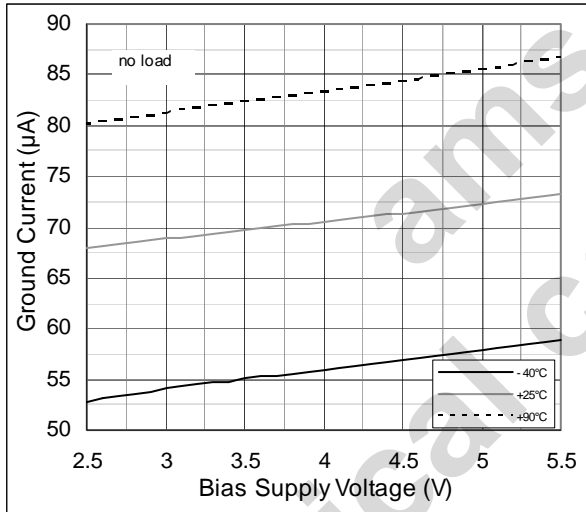

Figure 6. Ground Current vs. Bias Supply Voltage

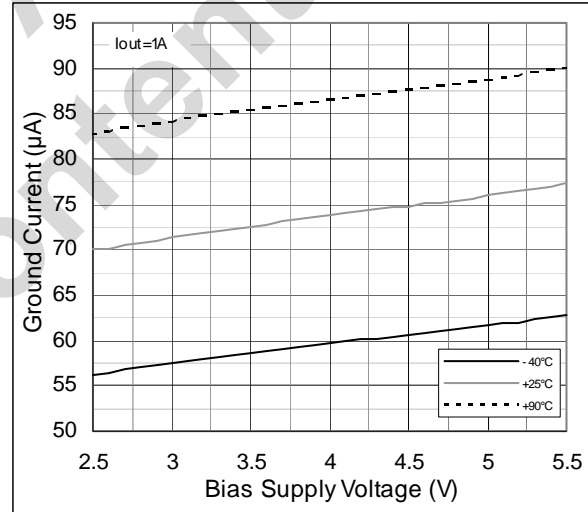

Figure 7. Ground Current vs. Bias Supply Voltage

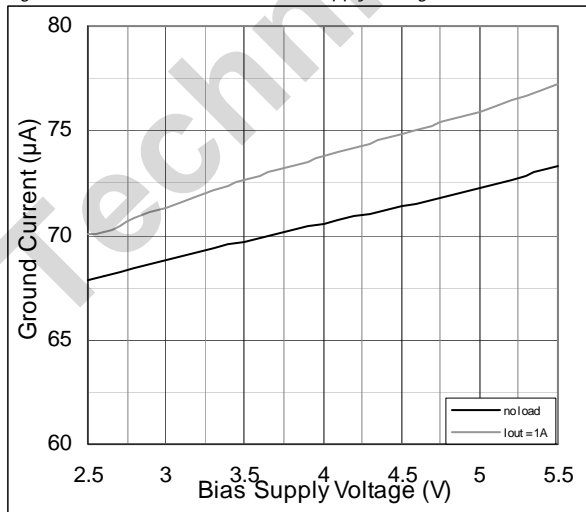

Figure 8. Ground Current vs. Load Current

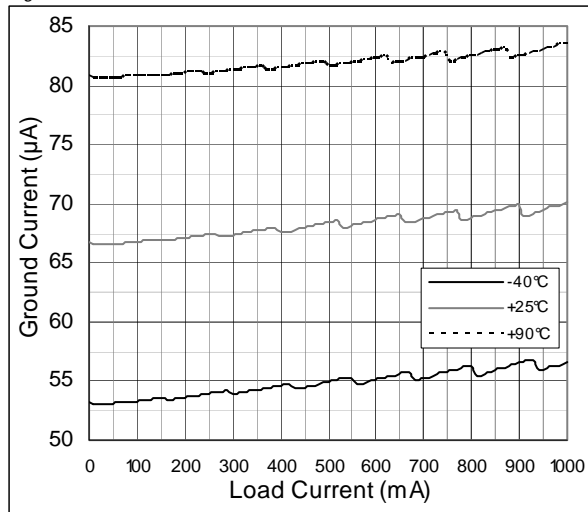

Figure 9. PSRR VIN ; VIN=1.5V_{DC} + 300mV_{pk}

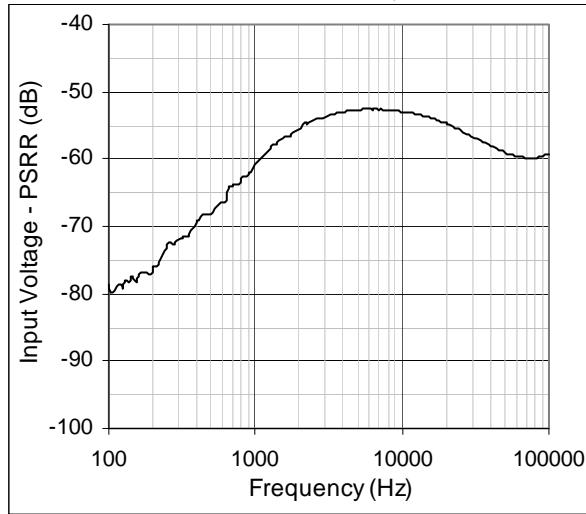

Figure 10. PSRR VBIAS; VBIAS=3.5V_{DC} + 500mV_{pk}

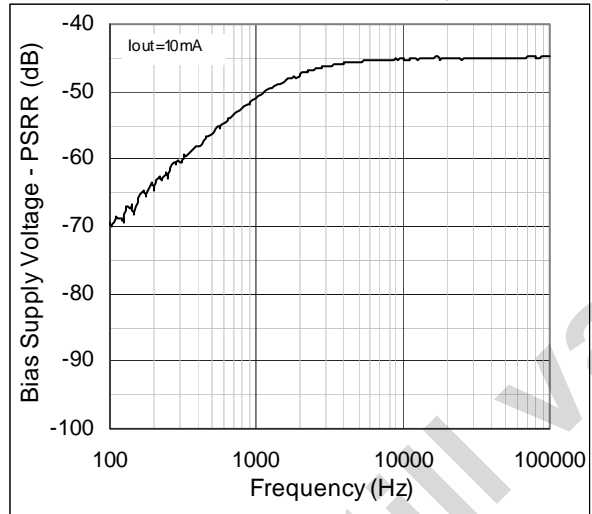

Figure 11. Line Regulation: V_{OUT} vs. V_{IN}; I_{OUT}=100μA

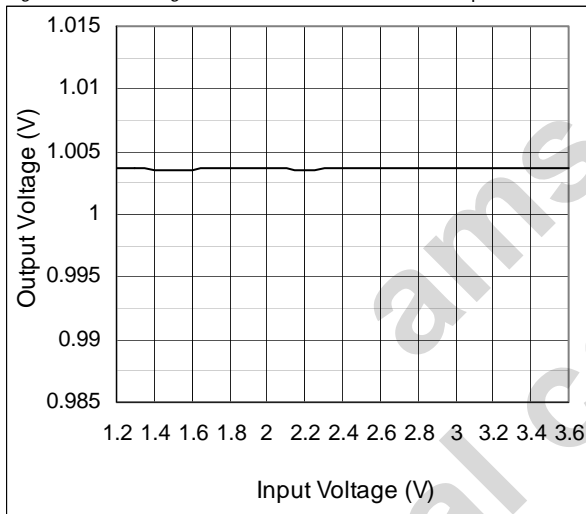

Figure 12. Line Regulation: V_{OUT} vs. V_{IN}; VBIAS=5.5V

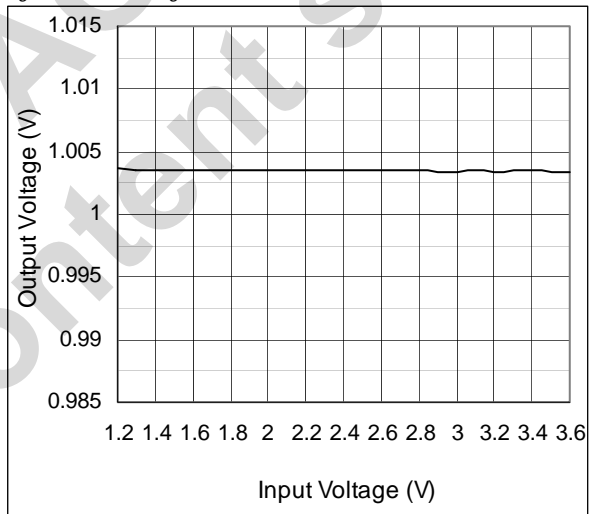

Figure 13. Load Regulation: V_{OUT} vs. I_{OUT}

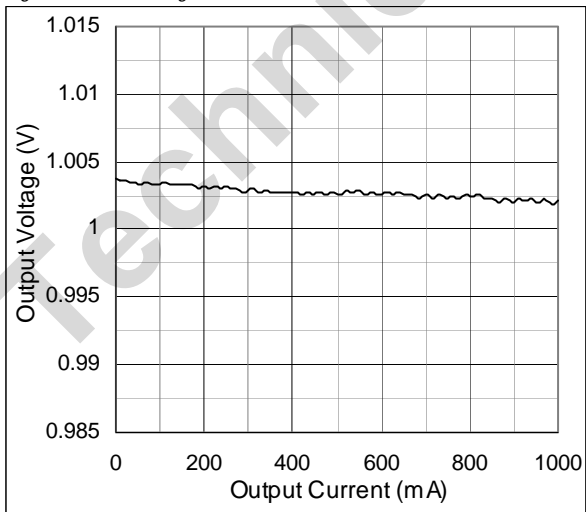

Figure 14. Output Voltage vs. Temperature; I_{OUT}=1mA

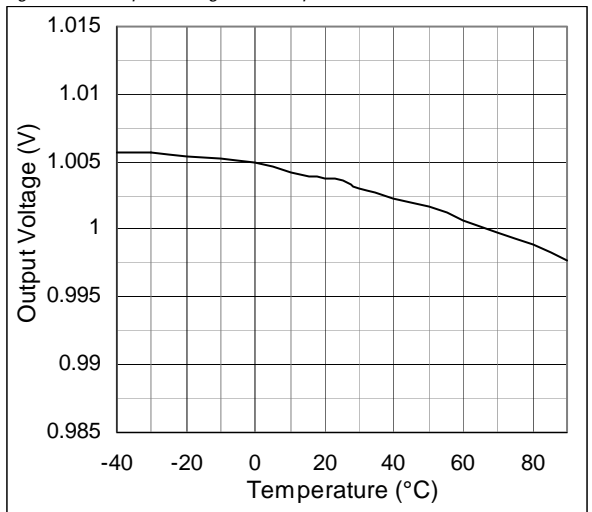

Figure 15. Dropout V_{IN} vs. Temperature; $I_{OUT}=1A$ 

Figure 16. Enable Start-up



8 Detailed Description

The AS1376 is a low-dropout, low-quiescent-current linear regulator intended for LDO regulator applications where output current load requirements range from no load to 1A. All devices come with fixed output voltage from 0.5V to 3.3V. (see [Ordering Information on page 18](#)).

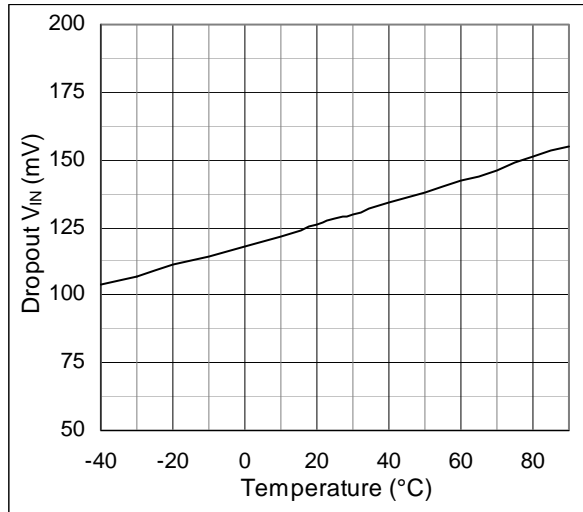
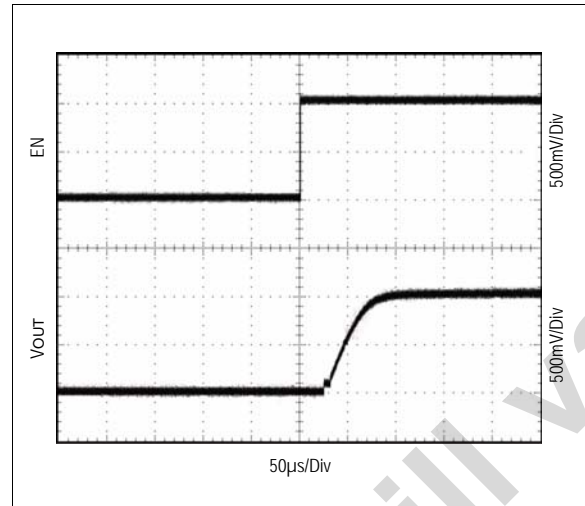
Shutdown current for the whole regulator is typically 20nA. The device has integrated short-circuit and over current protection. Under-Voltage lockout prevents erratic operation when the input voltage is slowly decaying (e.g. in a battery powered application). Thermal Protection shuts down the device when die temperature reaches 150°C. This is a useful protection when the device is under sustained short circuit conditions.

As illustrated in [Figure 17](#), the devices comprise voltage reference, error amplifier, N-channel MOSFET pass transistor, internal voltage divider, current limiter, thermal sensor and shutdown logic.

The bandgap reference is connected to the inverting input of the error amplifier. The error amplifier compares this reference with the feedback voltage and amplifies the difference. If the feedback voltage is lower than the reference voltage, the N-channel MOSFET gate is pulled higher, allowing more current to pass to the output, and increases the output voltage. If the feedback voltage is too high, the pass-transistor gate is pulled down, allowing less current to pass to the output.

When the adjustable output variant is selected, an external resistor voltage divider is connected to FB pin and a sample of the output is compared to the 500mV reference.

When a fixed output variant is chosen, FB must be connected to the Output pin. Depending upon the variant chosen, the internal reference is trimmed to the final output voltage. See [Electrical Characteristics \(page 4\)](#) for final voltages and tolerances.

Figure 17. AS1376 Block Diagram

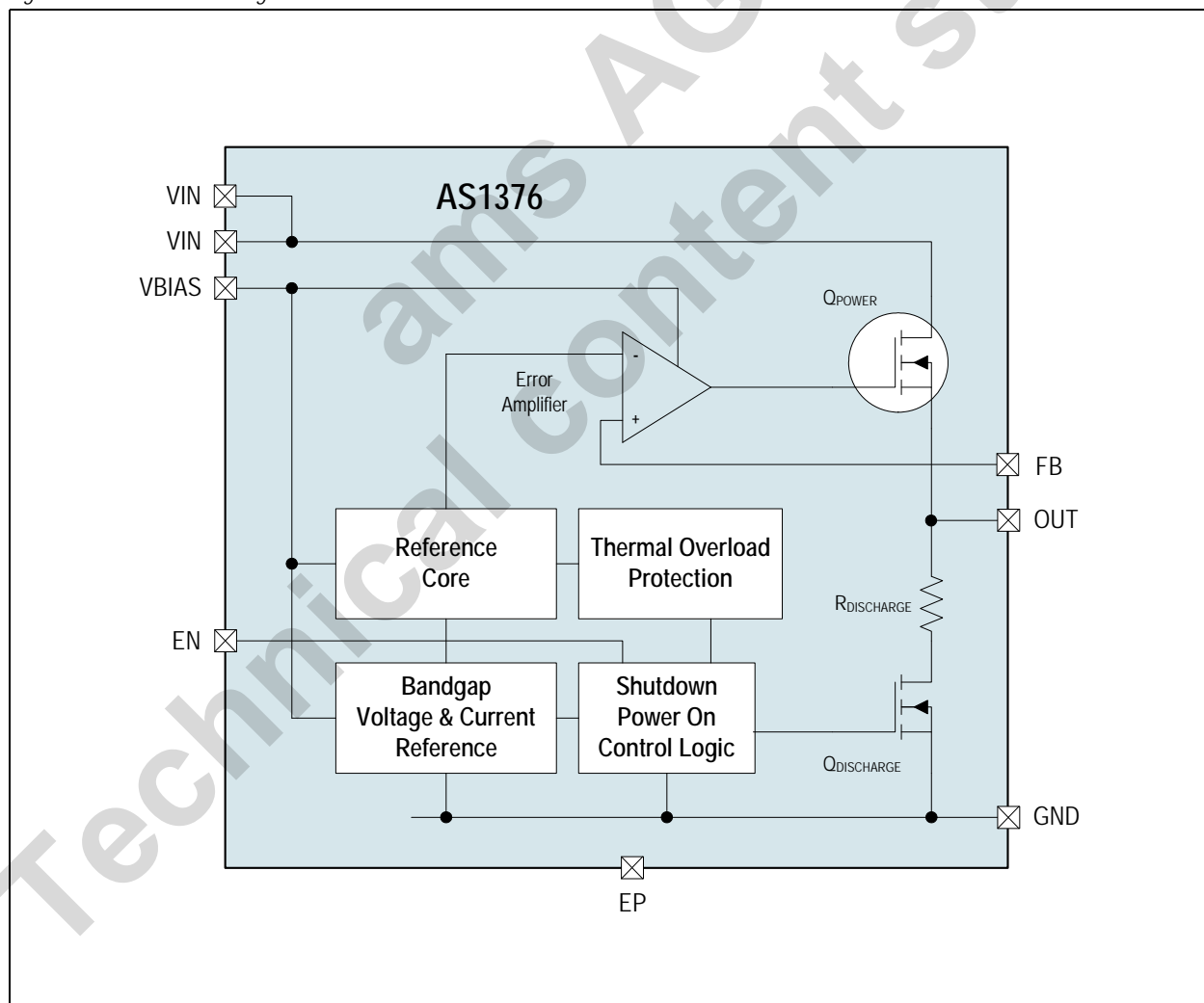

8.1 Output Voltages

Standard products are factory-set with output voltages from 0.5V to 2.2V. A two-digit suffix of the part number identifies the nominal output (see [Ordering Information on page 18](#)). Non-standard devices are available.

For more information contact: <http://www.austriamicrosystems.com/contact>

8.2 Advantages of Dual Supply Architecture vs Traditional Single Supply Approach

Compared to the traditional single supply approach, employing a P-channel series pass MOSFET, the dual rail architecture ensures improved performances in a LDO when operating at very low input voltages below the threshold of the internal series power N-channel MOSFET. The extra supply voltage at V_{BIAS} ($V_{BIAS} > V_{IN}$) ensures that the N-channel MOSFET always operates above its threshold voltage.

[Figure 18](#) shows simplified block diagrams of single supply P-channel LDO and dual rail N-channel series pass architectures.

Figure 18. Single vs. Dual Supply

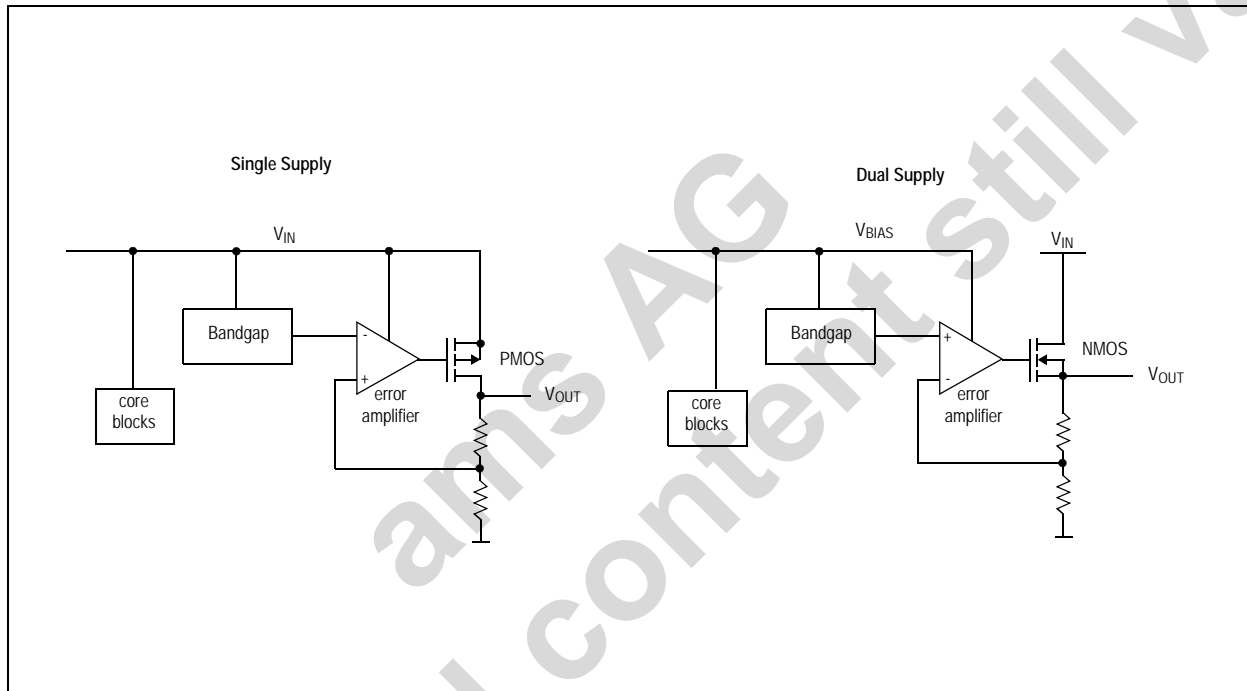

The P-channel LDO uses a PMOS output transistor connected in a common source configuration. During regulation, the P-channel gate-source voltage moves between V_{IN} and GND as the load demands. The dual supply approach is based on an N-channel output transistor in common drain configuration where the source is connected to the regulated output. During regulation, the N-channel gate source voltage increases from V_{OUT} to V_{BIAS} as the load demands. As the drain voltage is not shared with the remaining blocks of the circuit, its value can be chosen independently. The N-channel source follower design allows improved efficiency and dropout at low input voltages and provides faster load transient response.

9 Application Information

9.1 Dropout Voltage

Dropout is the input to output voltage difference, below which the linear regulator ceases to regulate. At this point, the output voltage change follows the input voltage change. Dropout voltage may be measured at different currents and, in particular at the regulator maximum one. From this is obtained the MOSFET maximum series resistance over temperature etc. More generally:

$$V_{DROPOUT} = I_{LOAD} \times R_{SERIES} \quad (EQ 1)$$

Dropout is probably the most important specification when the regulator is used in a battery application. The dropout performance of the regulator defines the useful "end of life" of the battery before replacement or re-charge is required.

Figure 19. Graphical Representation of Dropout Voltage

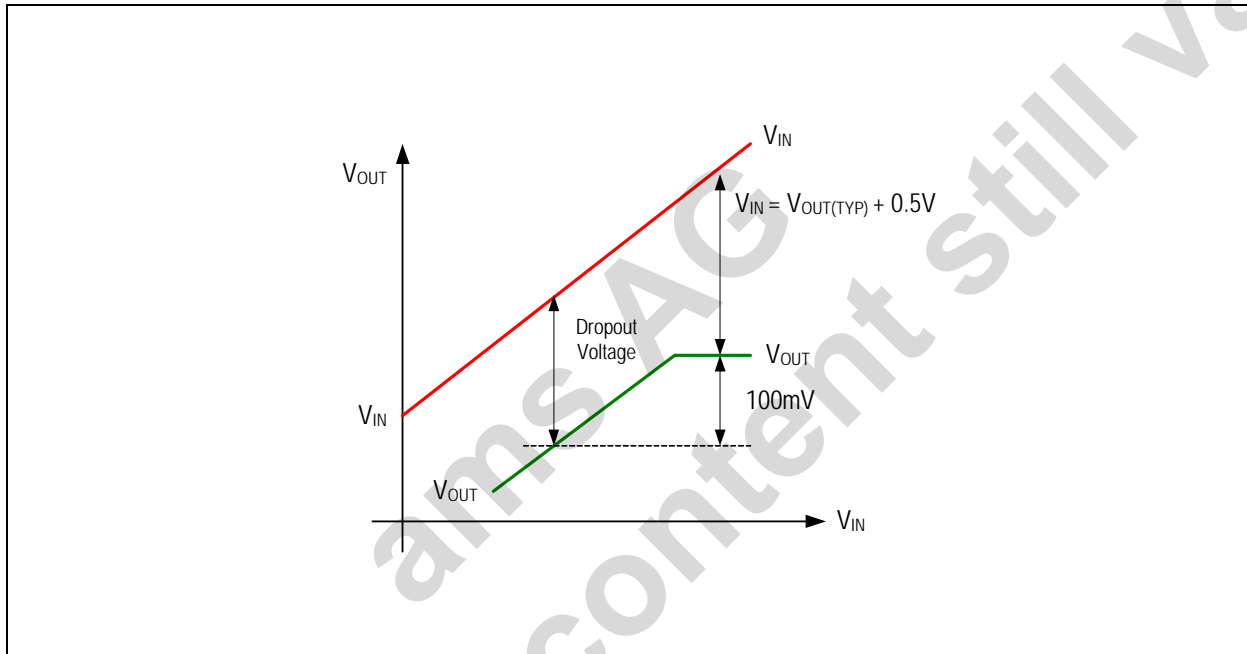

Figure 19 shows the variation of V_{OUT} as V_{IN} is varied for a certain load current. The practical value of dropout is the differential voltage ($V_{OUT} - V_{IN}$) measured at the point where the LDO output voltage has fallen by 100mV below the nominal, fully regulated output value. The nominal regulated output voltage of the LDO is that obtained when there is 500mV (or greater) input-output voltage differential.

9.2 Auto-Discharge

AS1376 features an auto-discharge function that discharges the load capacitance through a 100 Ω (typ) path to ground when the device is placed in shutdown. This helps to minimize the possibility that $V_{OUT} > V_{IN}$ during shutdown caused by differing capacitance discharge rates at V_{IN} and V_{OUT} terminals.

When $V_{OUT} > V_{IN}$, reverse current flows through the inherent body diode of the N-channel series pass transistor. This current should be limited to 50mA or less. If this is not possible, then an external Schottky diode should be connected between V_{OUT} (anode) and V_{IN} (cathode) to bypass the discharge current around the AS1376.

9.3 Efficiency

Low quiescent current and low input-output voltage differential are important in battery applications amongst others, as the regulator efficiency is directly related to quiescent current and dropout voltage. Efficiency is given by:

$$Efficiency = \frac{V_{LOAD} \times I_{LOAD}}{V_{IN}(I_Q + I_{LOAD})} \times 100 \% \quad (EQ 2)$$

Where:

I_Q = Quiescent current of LDO measured at V_{BIAS}

9.4 Power Dissipation

Maximum power dissipation (PD) of the LDO is the sum of the power dissipated by the internal series MOSFET and the quiescent current required to bias the internal voltage reference and the internal error amplifier, and is calculated as:

$$PD_{(MAX)}(Seriespass) = I_{LOAD(MAX)}(V_{IN(MAX)} - V_{OUT(MIN)}) \text{ Watts} \quad (EQ 3)$$

Internal power dissipation as a result of the bias current for the internal voltage reference and the error amplifier is calculated as:

$$PD_{(MAX)}(Bias) = V_{IN(MAX)}I_Q \text{ Watts} \quad (EQ 4)$$

Total LDO power dissipation is calculated as:

$$PD_{(MAX)}(Total) = PD_{(MAX)}(Seriespass) + PD_{(MAX)}(Bias) \text{ Watts} \quad (EQ 5)$$

9.5 Junction Temperature

Under all operating conditions, the maximum junction temperature should not be allowed to exceed 125°C (unless the data sheet specifically allows). Limiting the maximum junction temperature requires knowledge of the heat path from junction to case (θ_{JC} °C/W fixed by the IC manufacturer), and adjustment of the case to ambient heat path (θ_{CA} °C/W) by manipulation of the PCB copper area adjacent to the IC position.

Figure 20. Package Physical Arrangements

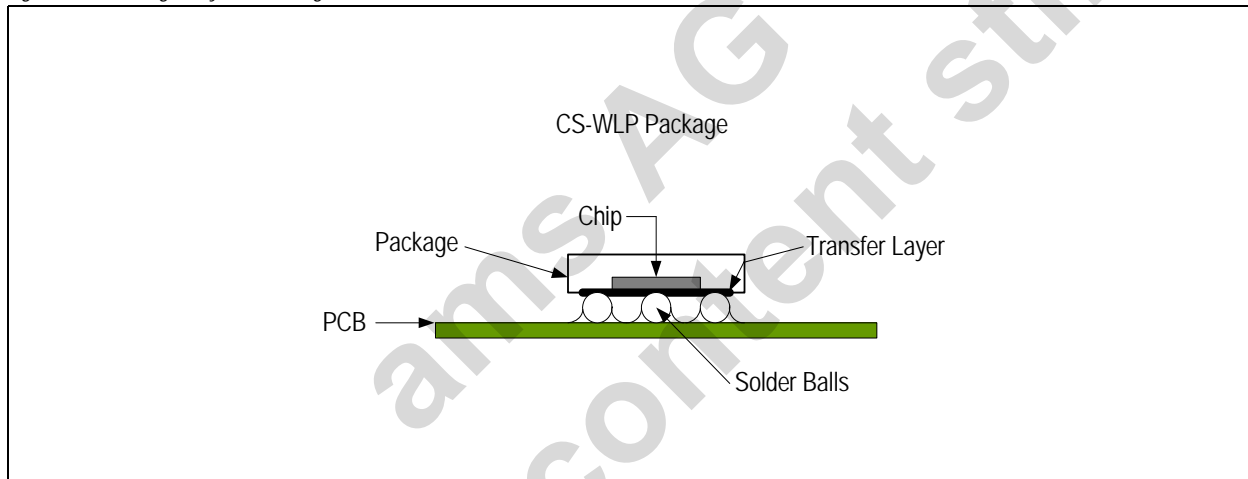
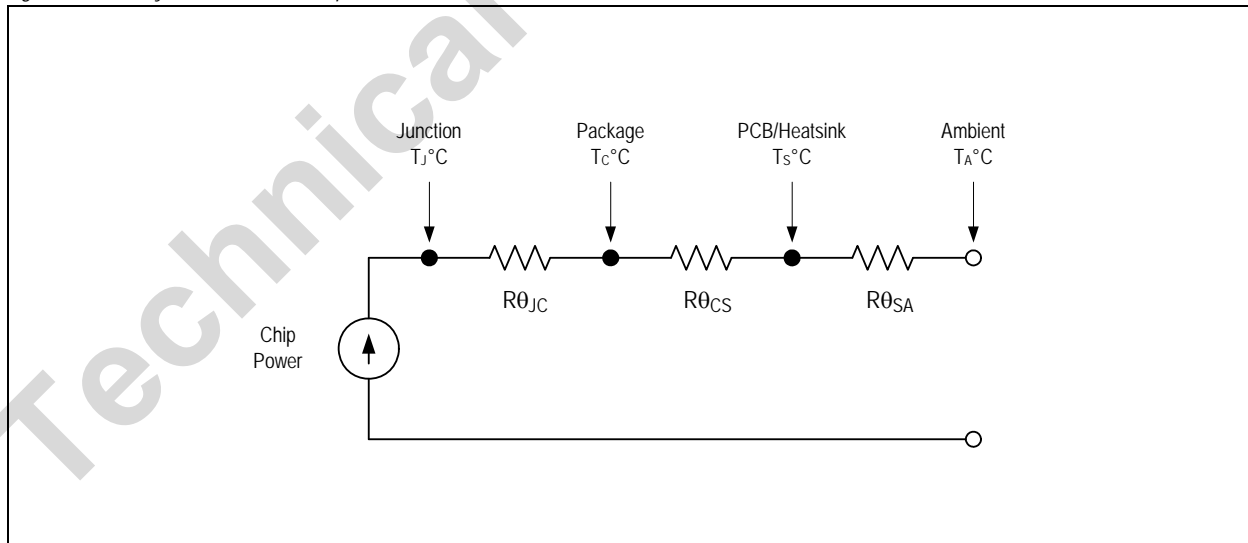

Figure 21. Steady State Heat Flow Equivalent Circuit



Total Thermal Path Resistance:

$$R\theta_{JA} = R\theta_{JC} + R\theta_{CS} + R\theta_{SA} \quad (\text{EQ } 6)$$

Junction Temperature (T_J °C) is determined by:

$$T_J = (PD_{(MAX)} \times R\theta_{JA}) + T_{AMB} \text{ } ^\circ\text{C} \quad (\text{EQ } 7)$$

9.6 Explanation of Steady State Specifications

9.6.1 Line Regulation

Line regulation is defined as the change in output voltage when the input (or line) voltage is changed by a known quantity. It is a measure of the regulator's ability to maintain a constant output voltage when the input voltage changes. Line regulation is a measure of the DC open loop gain of the error amplifier. More generally:

$$\text{Line Regulation} = \frac{\Delta V_{OUT}}{\Delta V_{IN}} \text{ and is a pure number} \quad (\text{EQ } 8)$$

In practise, line regulation is referred to the regulator output voltage in terms of % / V_{OUT}. This is particularly useful when the same regulator is available with numerous output voltage trim options.

$$\text{Line Regulation} = \frac{\Delta V_{OUT}}{\Delta V_{IN}} \times \frac{100}{V_{OUT}} \% / V \quad (\text{EQ } 9)$$

9.6.2 Load Regulation

Load regulation is defined as the change of the output voltage when the load current is changed by a known quantity. It is a measure of the regulator's ability to maintain a constant output voltage when the load changes. Load regulation is a measure of the DC closed loop output resistance of the regulator. More generally:

$$\text{Load Regulation} = \frac{\Delta V_{OUT}}{\Delta I_{OUT}} \text{ and is units of ohms } (\Omega) \quad (\text{EQ } 10)$$

In practise, load regulation is referred to the regulator output voltage in terms of % / mA. This is particularly useful when the same regulator is available with numerous output voltage trim options.

$$\text{Load Regulation} = \frac{\Delta V_{OUT}}{\Delta I_{OUT}} \times \frac{100}{\Delta V_{OUT}} \% / \text{mA} \quad (\text{EQ } 11)$$

9.6.3 Setting Accuracy

Accuracy of the final output voltage is determined by the accuracy of the ratio of R1 and R2, the reference accuracy and the input offset voltage of the error amplifier. When the regulator is supplied pre-trimmed, the output voltage accuracy is fully defined in the output voltage specification.

When the regulator has a SET terminal, the output voltage may be adjusted externally. In this case, the tolerance of the external resistor network must be incorporated into the final accuracy calculation. Generally:

$$V_{OUT} = (V_{SET} \pm \Delta V_{SET}) \left(1 + \frac{R1 \pm \Delta R1}{R2 \pm \Delta R2} \right) \quad (\text{EQ } 12)$$

The reference tolerance is given both at 25°C and over the full operating temperature range.

9.6.4 Total Accuracy

Away from dropout, total steady state accuracy is the sum of setting accuracy, load regulation and line regulation. Generally:

$$\text{Total \% Accuracy} = \text{Setting \% Accuracy} + \text{Load Regulation \%} + \text{Line Regulation \%} \quad (\text{EQ } 13)$$

9.7 Explanation of Dynamic Specifications

9.7.1 Power Supply Rejection Ratio (PSRR)

Known also as Ripple Rejection, this specification measures the ability of the regulator to reject noise and ripple beyond DC. PSRR is a summation of the individual rejections of the error amplifier, reference and AC leakage through the series pass transistor. The specification, in the form of a typical attenuation plot with respect to frequency, shows up the gain bandwidth compromises forced upon the designer in low quiescent current conditions. Generally:

$$PSSR = 20 \text{Log} \frac{\delta V_{OUT}}{\delta V_{IN}} \text{ dB using lower case } \delta \text{ to indicate AC values} \quad (\text{EQ 14})$$

Power supply rejection ratio is fixed by the internal design of the regulator. Additional rejection must be provided externally.

9.7.2 Output Capacitor ESR

The series regulator is a negative feedback amplifier, and as such is conditionally stable. The ESR of the output capacitor is usually used to cancel one of the open loop poles of the error amplifier in order to produce a single pole response. Excessive ESR values may actually cause instability by excessive changes to the closed loop unity gain frequency crossover point. The range of ESR values for stability is usually shown either by a plot of stable ESR versus load current, or a limit statement in the datasheet.

Some ceramic capacitors exhibit large capacitance and ESR variations with temperature and DC bias. Z5U and Y5V capacitors may be required to ensure stability at temperatures below $T_{AMB} = -10^{\circ}\text{C}$. With X7R or X5R capacitors, a $1\mu\text{F}$ capacitor should be sufficient at all operating temperatures.

Larger output capacitor values ($10\mu\text{F}$ max) help to reduce noise and improve load transient-response, stability and power-supply rejection.

9.7.3 Input Capacitor

If the AS1376 is used stand alone, an input capacitor at V_{IN} is required for stability. It is recommended that a $1.0\mu\text{F}$ capacitor be connected between the AS1376 power supply input pin V_{IN} and ground (capacitance value may be increased without limit).

This capacitor must be located at a distance of not more than 1cm from the V_{IN} pin and returned to a clean analog ground. Any good quality ceramic, tantalum, or film capacitor may be used at the input.

A capacitor at V_{BIAS} is not required if the distance to the supply does not exceed 5cm.

If the AS1376 device is used in the typical application as post regulator after a DC-DC regulator, no input capacitors are required at all as the capacitors of the DC-DC regulator (C_{IN} and C_{OUT}) are sufficient if both components are mounted close to each other and a proper GND plane is used. If the distance between the output capacitor of the DC-DC regulator and the V_{IN} pin of the AS1376 is larger than 5cm, a capacitor at V_{IN} is recommended.

9.7.4 Noise

The regulator output is a DC voltage with noise superimposed on the output. The noise comes from three sources: the reference, the error amplifier input stage, and the output voltage setting resistors. Noise is a random fluctuation and if not minimized in some applications, will produce system problems.

9.7.5 Transient Response

The series regulator is a negative feedback system, and therefore any change at the output will take a finite time to be corrected by the error loop. This "propagation time" is related to the bandwidth of the error loop. The initial response to an output transient comes from the output capacitance, and during this time, ESR is the dominant mechanism causing voltage transients at the output. More generally:

$$\delta V_{TRANSIENT} = \delta I_{OUTPUT} \times R_{ESR} \quad \text{Units are Volts, Amps, Ohms.} \quad (\text{EQ 15})$$

Thus an initial +50mA change of output current will produce a -12mV transient when the $ESR=240\text{m}\Omega$. Remember to keep the ESR within stability recommendations when reducing ESR by adding multiple parallel output capacitors.

After the initial ESR transient, there follows a voltage droop during the time that the LDO feedback loop takes to respond to the output change. This drift is approx. linear in time and sums with the ESR contribution to make a total transient variation at the output of:

$$\delta V_{TRANSIENT} = \delta I_{OUTPUT} \times \left(R_{ESR} + \frac{T}{C_{LOAD}} \right) \quad \text{Units are Volts, Seconds, Farads, Ohms.} \quad (\text{EQ 16})$$

Where:

C_{LOAD} is output capacitor

T = Propagation delay of the LDO

This shows why it is convenient to increase the output capacitor value for a better support for fast load changes. Of course the formula holds for $t < \text{"propagation time"}$, so that a faster LDO needs a smaller cap at the load to achieve a similar transient response. For instance 50mA load current step produces 50mV output drop if the LDO response is 1usec and the load cap is 1 μ F.

There is also a steady state error caused by the finite output impedance of the regulator. This is derived from the load regulation specification discussed above.

9.7.6 Exit from Shutdown Delay

This specification defines the time taken for the LDO to awake from shutdown. The time is measured from the release of the enable pin to the time that the output voltage is within 5% of the final value. It assumes that the voltage at V_{IN} is stable and within the regulator min and max limits. Shutdown reduces the quiescent current to very low, mostly leakage values ($< 1\mu$ A).

9.7.7 Thermal Protection

To prevent operation under extreme fault conditions, such as a permanent short circuit at the output, thermal protection is built into the device. Die temperature is measured, and when a 150°C threshold is reached, the device enters shutdown. When the die cools sufficiently, the device will restart (assuming input voltage exists and the device is enabled). Hysteresis of 25°C prevents low frequency oscillation between start-up and shutdown around the temperature threshold.

9.7.8 Power Supply Sequencing

The AS1376 requires two different supply voltages active at the same time for correct operation. They are as given below.

1. V_{IN} , the power input voltage, that is regulated to provide the fixed output voltage.
2. V_{BIAS} , the bias input voltage, supplies internal circuitry.

It's important that V_{IN} does not exceed V_{BIAS} at any time. If the device is used in the typical post regulation application as shown in [Figure 1](#), the sequencing of the two power supplies is not an issue as V_{BIAS} supplies both, the DC-DC regulator and the AS1376. The output voltage of the DC-DC regulator will take some time to rise up and supply V_{IN} of AS1376. In this application V_{IN} will always ramp up more slowly than V_{BIAS} . In case V_{IN} is shorted to V_{BIAS} , the voltages at the two supply pins will ramp up simultaneously causing no problem. Only in applications with two independent supplies connected to the AS1376 special care must be taken to guarantee that V_{IN} is always = V_{BIAS} .

9.7.9 Auto-Discharge

When the AS1376 is placed in shutdown, a 100 Ω path to ground is connected at the output. This path speeds up the discharge of the capacitor(s) connected to the regulator output. Assuming that V_{IN} remains constant and always $> V_{OUT}$, output discharge time is calculated from the following relationship:

$$V(t) = V_{REG} e^{-\frac{t}{RC}} \quad (EQ 17)$$

Where:

t = specified time after regulator shutdown (sec)

V_{REG} = Regulated output voltage (initial condition)

R = 100 Ω (typ) discharge resistance

C = Output capacitance (Farad)

In other words, the output discharge will reach 90% below the regulated output voltage in 2.2RC seconds; R and C defined as above.

10 Package Drawings and Markings

The device is available in a 8-pin 2x2mm TDFN package.

Figure 22. Drawings and Dimensions

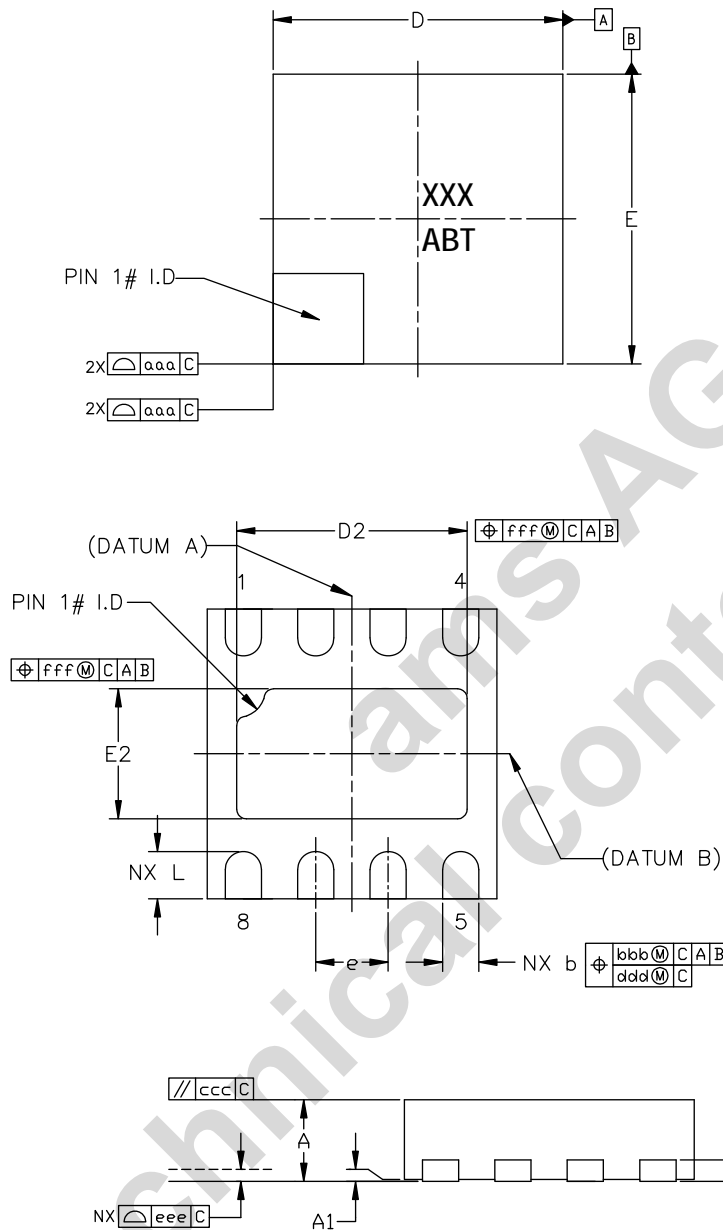

Symbol	Min	Nom	Max
A	0.51	0.55	0.60
A1	0.00	0.02	0.05
A3	0.15 REF		
L	0.225	0.325	0.425
b	0.18	0.25	0.30
D	2.00 BSC		
E	2.00 BSC		
e	0.50 BSC		
D2	1.45	1.60	1.70
E2	0.75	0.90	1.00
aaa	-	0.15	-
bbb	-	0.10	-
ccc	-	0.10	-
ddd	-	0.05	-
eee	-	0.08	-
fff	-	0.10	-
N	8		



Notes:

1. Dimensions and tolerancing conform to ASME Y14.5M-1994.
2. All dimensions are in millimeters. Angles are in degrees.
3. Coplanarity applies to the exposed heat slug as well as the terminal.
4. Radius on terminal is optional.
5. N is the total number of terminals.

Revision History

Revision	Date	Owner	Description
1.2			Initial revision
1.3	12 Oct, 2011	afe	Changes made across document for version 1.3
1.4	12 Dec, 2011		Updated equations in Power Dissipation section

Note: Typos may not be explicitly mentioned under revision history.

ams AG
Technical content still valid

11 Ordering Information

The device is available as the standard products listed in [Table 4](#).

Table 4. Ordering Information

Ordering Code	Marking	Output	Description	Delivery Form	Package
AS1376-BTDT-AD ¹	ABL	adj	1A, Low Input Voltage, Low Quiescent Current LDO	Tape and Reel	8-pin 2x2mm TDFN
AS1376-BTDT-08 ¹	ABM	0.8V	1A, Low Input Voltage, Low Quiescent Current LDO	Tape and Reel	8-pin 2x2mm TDFN
AS1376-BTDT-10 ¹	ABN	1.0V	1A, Low Input Voltage, Low Quiescent Current LDO	Tape and Reel	8-pin 2x2mm TDFN
AS1376-BTDT-12	ABT	1.2V	1A, Low Input Voltage, Low Quiescent Current LDO	Tape and Reel	8-pin 2x2mm TDFN
AS1376-BTDT-20 ¹	ABP	2.0V	1A, Low Input Voltage, Low Quiescent Current LDO	Tape and Reel	8-pin 2x2mm TDFN
AS1376-BTDT-22 ¹	ABQ	2.2V	1A, Low Input Voltage, Low Quiescent Current LDO	Tape and Reel	8-pin 2x2mm TDFN

1. Available on request

Non-standard devices from 0.5V to 1.1V are available in 50mV steps and from 1.1V and 2.2V in 100mV steps. For more information and inquiries contact <http://www.austriamicrosystems.com/contact>

Note: All products are RoHS compliant.

Buy our products or get free samples online at ICdirect: <http://www.austriamicrosystems.com/ICdirect>

Technical Support is available at <http://www.austriamicrosystems.com/Technical-Support>

For further information and requests, please contact us [mailto: sales@austriamicrosystems.com](mailto:sales@austriamicrosystems.com) or find your local distributor at <http://www.austriamicrosystems.com/distributor>

Copyrights

Copyright © 1997-2011, austriamicrosystems AG, Tobelbaderstrasse 30, 8141 Unterpremstaetten, Austria-Europe. Trademarks Registered ®. All rights reserved. The material herein may not be reproduced, adapted, merged, translated, stored, or used without the prior written consent of the copyright owner.

All products and companies mentioned are trademarks or registered trademarks of their respective companies.

Disclaimer

Devices sold by austriamicrosystems AG are covered by the warranty and patent indemnification provisions appearing in its Term of Sale. austriamicrosystems AG makes no warranty, express, statutory, implied, or by description regarding the information set forth herein or regarding the freedom of the described devices from patent infringement. austriamicrosystems AG reserves the right to change specifications and prices at any time and without notice. Therefore, prior to designing this product into a system, it is necessary to check with austriamicrosystems AG for current information. This product is intended for use in normal commercial applications. Applications requiring extended temperature range, unusual environmental requirements, or high reliability applications, such as military, medical life-support or life-sustaining equipment are specifically not recommended without additional processing by austriamicrosystems AG for each application. For shipments of less than 100 parts the manufacturing flow might show deviations from the standard production flow, such as test flow or test location.

The information furnished here by austriamicrosystems AG is believed to be correct and accurate. However, austriamicrosystems AG shall not be liable to recipient or any third party for any damages, including but not limited to personal injury, property damage, loss of profits, loss of use, interruption of business or indirect, special, incidental or consequential damages, of any kind, in connection with or arising out of the furnishing, performance or use of the technical data herein. No obligation or liability to recipient or any third party shall arise or flow out of austriamicrosystems AG rendering of technical or other services.



Contact Information

Headquarters

austriamicrosystems AG
Tobelbaderstrasse 30
A-8141 Unterpremstaetten, Austria
Tel: +43 (0) 3136 500 0
Fax: +43 (0) 3136 525 01

For Sales Offices, Distributors and Representatives, please visit:

<http://www.austriamicrosystems.com/contact>