



Grayhill, Inc.

62S11-H9-P

Номер на частта: 62S11-H9-P

Производител / марка: Grayhill, Inc.

Описание на продукта: ROTARY ENCODER OPTICAL 32PPR

Информационни листове:  62S11-H9-P.pdfСтатус на RoHS:  Без съдържание на олово / RoHS съвместимо

Състояние на запаса: 2159 pcs stock

Кораб от: Хонг Конг

Път на превоза: DHL/Fedex/TNT/UPS/EMS

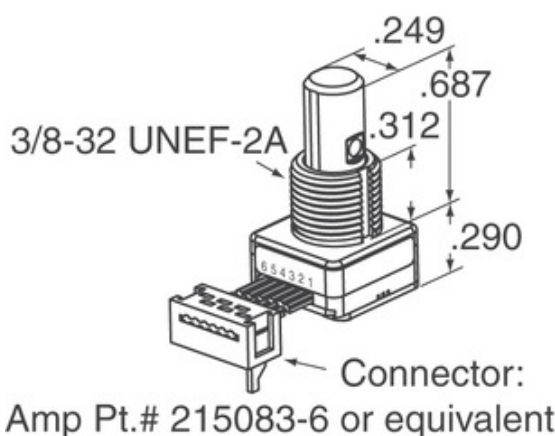

Изображението може да е представяне. Вижте спецификациите за подробности за продукта.

[ЗАПИТВАНЕ ЗА ОФЕРТА](#)



Спецификации на 62S11-H9-P

НОМЕР НА ЧАСТТА	62S11-H9-P
ПРОИЗВОДИТЕЛ	Grayhill, Inc.
ОПИСАНИЕ	ROTARY ENCODER OPTICAL 32PPR
СТАТУС ЗА СВОБОДНО СЪСТОЯНИЕ / СЪСТОЯНИЕ НА ROHS	Без съдържание на олово / RoHS съвместимо
НАЛИЧНО КОЛИЧЕСТВО	2159 pcs
ИНФОРМАЦИОНЕН ЛИСТ	 62S11-H9-P.pdf
НАПРЕЖЕНИЕ - ДОСТАВКА	5V
СТИЛ НА ПРЕКРАТЯВАНЕ	PC Pin
СЕРИЯ	62S
РОТАЦИОНЕН ЖИВОТ (ЦИКЛИ МИН.)	1M
ИМПУЛСИ НА РЕВОЛЮЦИЯ	32
ТИП НА ИЗХОДА	Quadrature (Incremental)
ДРУГИ ИМЕНА	62S11H9P
ОРИЕНТАЦИЯ	Vertical
ТИП МОНТАЖ	PCB, Through Hole
НИВО НА ЧУВСТВИТЕЛНОСТ КЪМ ВЛАГА (MSL)	1 (Unlimited)
СТАТУС ЗА СВОБОДНО СЪСТОЯНИЕ / СЪСТОЯНИЕ НА ROHS	Lead free / RoHS Compliant
ТИП ЕНКОДЕР	Optical
ОГРАНИЧИТЕЛ	Yes
ВГРАДЕН SWITCH	Yes
ТИП НА ЗАДВИЖВАНЕТО	1/4" Dia Flatted End

Свързани маркери

Grayhill, Inc. 62S11-H9-P	62S11-H9-P дистрибутор	62S11-H9-P доставчик
Цена 62S11-H9-P	62S11-H9-P Снимки	62S11-H9-P Изображение
PDF Datasheet	62S11-H9-P Изтегляне на листа с данни	62S11-H9-P Технически данни
Запас от 62S11-H9-P	Купете 62S11-H9-P	Купете Grayhill, Inc. 62S11-H9-P
Grayhill, Inc. 62S11-H9-P	Grayhill, Inc. Доставчик	Grayhill, Inc. дистрибутор
Grayhill, Inc. 62S11-H9-P	Grayhill Inc. 62S11-H9-P	

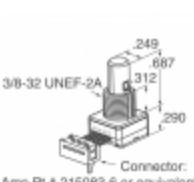
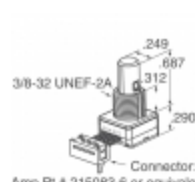
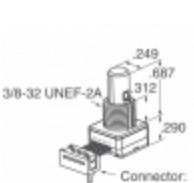
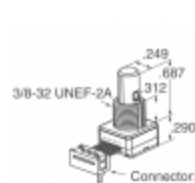
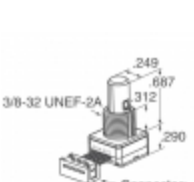
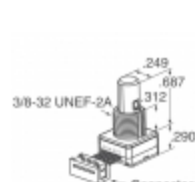
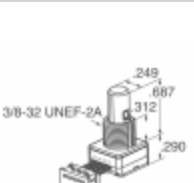
Свързани продукти

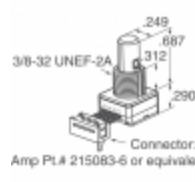
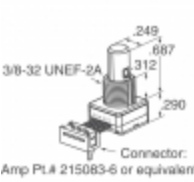
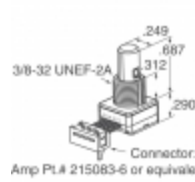
 <p>62S11-H9-040C Производители: Grayhill, Inc. описание: ROTARY ENCODER OPTICAL 32PPR В наличност: 1975 pcs</p> <p>RFQ</p>	 <p>62S11-L0-040C Производители: Grayhill, Inc. описание: ROTARY ENCODER OPTICAL 32PPR В наличност: 2079 pcs</p> <p>RFQ</p>
 <p>62S11-H9-040S Производители: Grayhill, Inc. описание: ROTARY ENCODER OPTICAL 32PPR В наличност: 2086 pcs</p> <p>RFQ</p>	 <p>62S11-H9-025S Производители: Grayhill, Inc. описание: ROTARY ENCODER OPTICAL 32PPR В наличност: 2155 pcs</p> <p>RFQ</p>
 <p>62S11-L0-020C Производители: Grayhill, Inc. описание: ROTARY ENCODER OPTICAL 32PPR В наличност: 1839 pcs</p> <p>RFQ</p>	 <p>62S11-L0-055C Производители: Grayhill, Inc. описание: ROTARY ENCODER OPTICAL 32PPR В наличност: 1995 pcs</p> <p>RFQ</p>
 <p>62S11-H9-050S Производители: Grayhill, Inc. описание: ROTARY ENCODER OPTICAL 32PPR В наличност: 1839 pcs</p> <p>RFQ</p>	 <p>62S11-L0-020CH Производители: Grayhill, Inc. описание: ROTARY ENCODER OPTICAL 32PPR В наличност: 2105 pcs</p> <p>RFQ</p>
 <p>62S11-L0-040S Производители: Grayhill, Inc. описание: ROTARY ENCODER OPT 32PPR 4" CBL В наличност: 2058 pcs</p> <p>RFQ</p>	 <p>62S11-H9-PH Производители: Grayhill, Inc. описание: ROTARY ENCODER OPTICAL 32PPR В наличност: 2090 pcs</p> <p>RFQ</p>
 <p>62S11-H9-060C Производители: Grayhill, Inc. описание: ROTARY ENCODER OPTICAL 32PPR В наличност: 2172 pcs</p> <p>RFQ</p>	 <p>62S11-H9-060SH Производители: Grayhill, Inc. описание: ROTARY ENCODER OPTICAL 32PPR В наличност: 1966 pcs</p> <p>RFQ</p>

Copyright © 2020 надежен дистрибутор на електронни компоненти

Електронна поща: Info@infinity-electronic.com

Адрес: 17F, търговска сграда Gaylord, 114-118 Lockhart Road, Wan Chai, Хонгконг

