



Grayhill, Inc.

62S11-M5-020CH

Номер на частта:

62S11-M5-020CH

Производител / марка:

Grayhill, Inc.

Описание на продукта

ROTARY ENCODER OPTICAL 32PPR

Информационни листове:

 62S11-M5-020CH.pdf

Статус на RoHS

 Без съдържание на олово / RoHS съвместимо

Състояние на запаса

1977 pcs stock

Кораб от

Хонг Конг

Път на превоза

DHL/Fedex/TNT/UPS/EMS

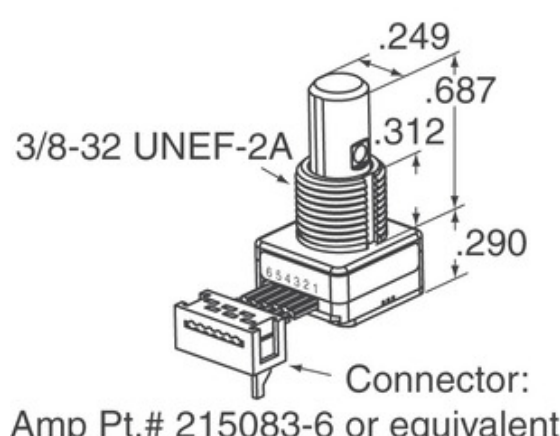

Изображението може да е представяне. Вижте спецификациите за подробности за продукта.

[ЗАПИТВАНЕ ЗА ОФЕРТА](#)







Спецификации на 62S11-M5-020CH

НОМЕР НА ЧАСТТА	62S11-M5-020CH
ПРОИЗВОДИТЕЛ	Grayhill, Inc.
ОПИСАНИЕ	ROTARY ENCODER OPTICAL 32PPR
СТАТУС ЗА СВОБОДНО СЪСТОЯНИЕ / СЪСТОЯНИЕ НА ROHS	Без съдържание на олово / RoHS съвместимо
НАЛИЧНО КОЛИЧЕСТВО	1977 pcs
ИНФОРМАЦИОНЕН ЛИСТ	 62S11-M5-020CH.pdf
НАПРЕЖЕНИЕ - ДОСТАВКА	5V
СТИЛ НА ПРЕКРАТЯВАНЕ	Cable with Connector
СЕРИЯ	62S
РОТАЦИОНЕН ЖИВОТ (ЦИКЛИ МИН.)	1M
ИМПУЛСИ НА РЕВОЛЮЦИЯ	32
ТИП НА ИЗХОДА	Quadrature (Incremental)
ДРУГИ ИМЕНА	62S11M5020CH
ОРИЕНТАЦИЯ	Vertical
ТИП МОНТАЖ	Panel Mount
НИВО НА ЧУВСТВИТЕЛНОСТ КЪМ ВЛАГА (MSL)	1 (Unlimited)
СТАТУС ЗА СВОБОДНО СЪСТОЯНИЕ / СЪСТОЯНИЕ НА ROHS	Lead free / RoHS Compliant
ТИП ЕНКОДЕР	Optical
ОГРАНИЧИТЕЛ	Yes
ВГРАДЕН SWITCH	Yes
ТИП НА ЗАДВИЖВАНЕТО	1/4" Dia Flatted End

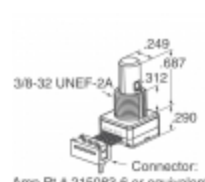
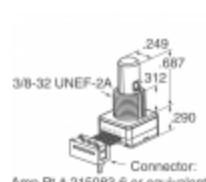
Свързани маркери

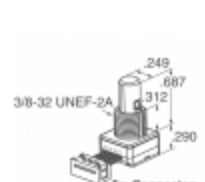
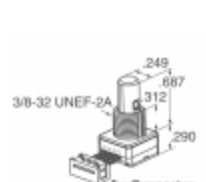
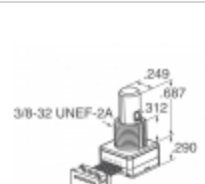
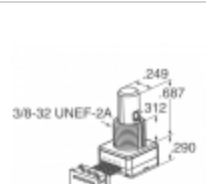
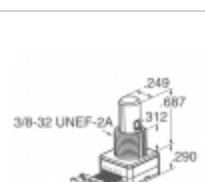
Grayhill, Inc. 62S11-M5-020CH	62S11-M5-020CH дистрибутор	62S11-M5-020CH доставчик
Цена 62S11-M5-020CH	62S11-M5-020CH Снимки	62S11-M5-020CH Изображение
PDF Datasheet	62S11-M5-020CH Изтегляне на листа с данни	62S11-M5-020CH Технически данни
Запас от 62S11-M5-020CH	Купете 62S11-M5-020CH	Купете Grayhill, Inc. 62S11-M5-020CH
Grayhill, Inc. 62S11-M5-020CH	Grayhill, Inc. Доставчик	Grayhill, Inc. дистрибутор
Grayhill, Inc. 62S11-M5-020CH	Grayhill Inc. 62S11-M5-020CH	

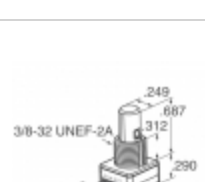
Свързани продукти

 <p>62S11-M5-040C Производители: Grayhill, Inc. описание: ROTARY ENCODER OPTICAL 32PPR В наличност: 2150 pcs</p> <p>RFQ</p>	 <p>62S11-M0-200S Производители: Grayhill, Inc. описание: ROTARY ENCODER OPTICAL 32PPR В наличност: 2199 pcs</p> <p>RFQ</p>
 <p>62S11-M5-050C Производители: Grayhill, Inc. описание: ROTARY ENCODER OPT 32PPR 5" CBL В наличност: 3137 pcs</p> <p>RFQ</p>	 <p>62S11-M0-210SH Производители: Grayhill, Inc. описание: ROTARY ENCODER OPT 32PPR 20" CBL В наличност: 2126 pcs</p> <p>RFQ</p>
 <p>62S11-M5-030C Производители: Grayhill, Inc. описание: ROTARY ENCODER OPTICAL 32PPR В наличност: 2076 pcs</p> <p>RFQ</p>	 <p>62S11-M5-020SH Производители: Grayhill, Inc. описание: ROTARY ENCODER OPT 32PPR 2" CBL В наличност: 1912 pcs</p> <p>RFQ</p>
 <p>62S11-M5-030CH Производители: Grayhill, Inc. описание: ROTARY ENCODER OPTICAL 32PPR В наличност: 1862 pcs</p> <p>RFQ</p>	 <p>62S11-M0-PH Производители: Grayhill, Inc. описание: ROTARY ENCODER OPTICAL 32PPR В наличност: 2503 pcs</p> <p>RFQ</p>
 <p>62S11-M0-PV Производители: Grayhill, Inc. описание: ROTARY ENCODER OPTICAL 32PPR В наличност: 2105 pcs</p> <p>RFQ</p>	 <p>62S11-M0-P Производители: Grayhill, Inc. описание: ROTARY ENCODER OPTICAL 32PPR В наличност: 1933 pcs</p> <p>RFQ</p>
 <p>62S11-M5-020S Производители: Grayhill, Inc. описание: ROTARY ENCODER OPTICAL 32PPR В наличност: 2069 pcs</p> <p>RFQ</p>	 <p>62S11-M5-020C Производители: Grayhill, Inc. описание: ROTARY ENCODER OPT 32PPR 2" CBL В наличност: 2181 pcs</p> <p>RFQ</p>

Copyright © 2020 надежен дистрибутор на електронни компоненти

Електронна поща: Info@infinity-electronic.com

Адрес: 17F, търговска сграда Gaylord, 114-118 Lockhart Road, Wan Chai, Хонгконг

